

**MULTI CONCEPT
MX-CHASSIS
(100 Hz, 4:3)**

TV
1998

Ⓒ **Service manual**
Ⓓ **Service-Manual**
Ⓔ **Serviceanvisning**

Ⓕ **Manuel de service**
Ⓖ **Manuale di servizio**

AKAI

TV 2561-TN 100 Hz
TV 2861-TN 100 Hz
TV 2961-TN 100 Hz
TV 2561-T Multi 100 Hz
TV 2861-T Multi 100 Hz
TV 2961-T Multi 100 Hz 3D VGA

NOKIA

63L3-TN 100 Hz
71L3-TN 100 Hz
63L3-T Multi 100 Hz
71L3-T Multi 100 Hz
74F3-TN 100 Hz
74F3-T Multi 100 Hz 3D VGA

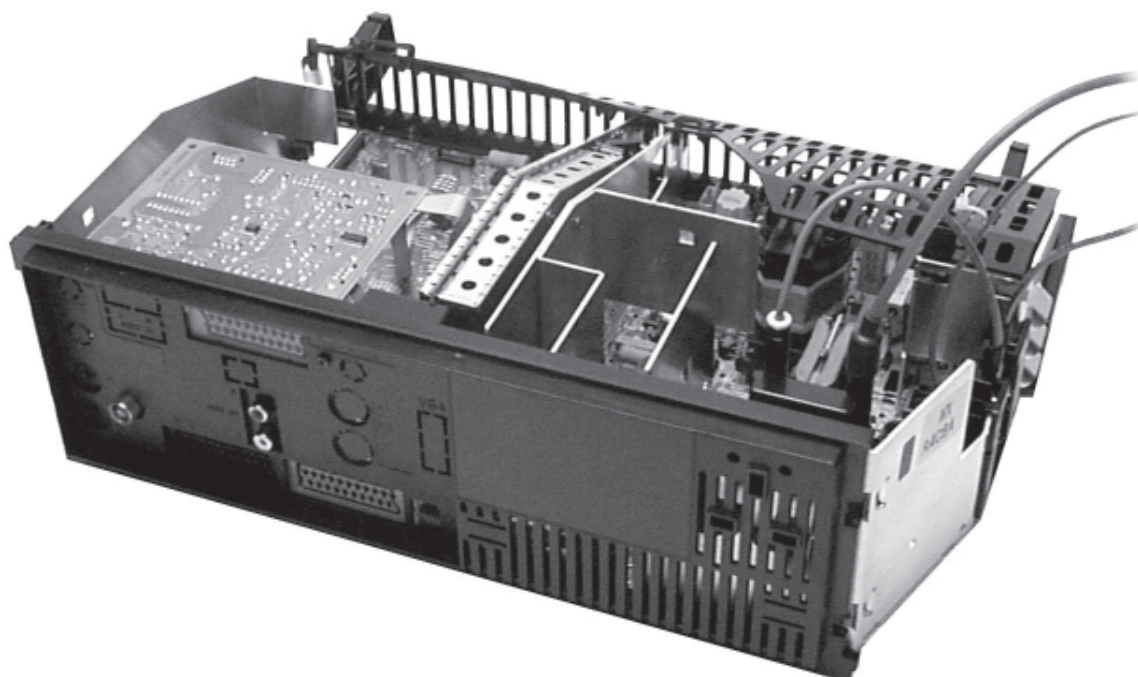

GB Contents

Repair instructions	1
Technical data	2
Block diagrams	3
SCART connector	6
Operating instructions	7
Initialization of NVRAM	7
Service adjustments	8
Schematic diagrams	27
Variable components	43
Spare parts	44

D Inhaltsverzeichnis

Reparatur Anweisung	1
Technische Daten	2
Blockschaltbildern	3
SCART Anschluß	6
Bedienungsanleitung	11
Initialisierung des NVRAM	11
Service-Einstellungen	12
Schaltpläne	27
Röhrenabhängige Bauteile	43
Ersatzteilleiste	44

S Innehåll

Reparationsinstruktioner	1
Tekniska data	2
Blockschemor	3
SCART-kontakt	6
Bruksanvisning	15
Initialisering av NVRAM	15
Serviceinställningar	16
Kopplingschemor	27
Komponentskillnader	43
Reservdelar	44

F Contenu

Instructions de réparation	1
Données techniques	2
Diagrammes des blocs	3
Connecteur SCART	6
Mode d'emploi	19
Initialisation de la NVRAM	19
Réglages de service	20
Schéma	27
Composants variables	43
Pièces de rechange	44

I Indice

Istruzioni di servizio	1
Dati tecnici	2
Diagramma di blocco	3
Connettore SCART	6
Istruzioni d'uso	23
Inizializzazione della NVRAM	23
Regolazioni di servizio	24
Schema elettrico	27
Componenti che differiscono	43
Parti di ricambio	44

GB Repair instructions

Service and repair work must be performed only in accordance with existing safety regulations!

Where a high current or mechanical stress exists solder connections have been strengthened by using eyelets. Such a connection must not be left without an eyelet.

Wiring has an effect on safety and EMC (Electro-Magnetic Compatibility). Therefore wires must be maintained in their original positions.

X-RAY REGULATIONS:

The picture tube type and the maximum permissible high-voltage ensure that the X-ray intensity of the receiver remains far below the permissible value. The high-voltage must not exceed the value mentioned on the type label. The high voltage is within the permissible limits when the operating voltage (U1) of the horizontal deflection stage is accurate. Refer to the section "Service adjustments".

ESD Warning

The receiver contains components that are sensitive to electrostatic discharge (ESD). Any servicing or repair work must be done in an environment where the components will not be subjected to ESD. Use a special grounding device!

D Reparatur Anweisung

Bei Reparaturen gültige Sicherheitsvorschriften beachten!

Lötverbindungen die einem hohen Stromfluß oder starker mechanischer Beanspruchung unterliegen wurden durch Lötösen verstärkt. Eine derart belastete Lötverbindung darf nicht ohne Lötöse verbleiben.

Die Lage der Kabel hat einen Einfluß auf die Betriebssicherheit und das EMV Verhalten (Elektro Magnetische Verträglichkeit) des Geräts. Aus diesem Grund müssen die Kabel in ihrer originalen Position verbleiben.

RÖNTGENVERORDNUNG:

Der Bildröhrentyp und die maximal zulässige Hochspannung stellen sicher, daß die Röntgenstrahlenintensität des Fernsehgerätes weit unter dem zulässigen Wert bleibt. Die Kathodenhochspannung darf den auf dem Typenschild angegebenen Wert nicht überschreiten. Die Hochspannung liegt im zulässigen Bereich, wenn die Betriebsspannung (U1) der Horizontal-Ablenkstufe genau eingehalten wird. Siehe auch Abschnitt "Service-Einstellungen".

EGB-Warnung

Das Fernsehgerät enthält Bauteile, die empfindlich auf elektrostatische Entladung reagieren. Alle Service- oder Reparaturarbeiten sind in einer Umgebung durchzuführen, in der die Bauteile nicht elektrostatischer Entladung ausgesetzt sind. Verwenden Sie eine spezielle Erdungsvorrichtung!

S Reparationsinstruktioner

Gällande säkerhetsdirektiv måste beaktas vid service-ingrepp!

Lödpunkter, som kan utsättas av hög ström eller mekanisk belastning, har förstärkts genom holkning. Dessa lödpunkter får inte lämnas utan denna förstärkning.

Kabeldragningen inverkar på säkerhet och EMC (Elektromagnetisk anpassning). Kabel-dragningen måste därför utföras enligt originalutförande.

RÖNTGENSTRÅLNING:

Med hjälp av bildrörstyp och begränsning av maximum högspänning kan mottagarens röntgenstrålning hållas under tillåten nivå. Höspänningen får inte överskrida värdet som nämns på typetiketten. Högspeänningen är inom tillåten nivå när horizontalslutstegets drivspänning (U1) är rätt inställd. Se avsnitt "Service inställningar".

ESD (Statisk elektricitet)

Mottagaren är utrustad med komponenter som är känsliga för statisk elektricitet (ESD). Servicearbetet måste därför göras så att komponenterna inte utsätts för statisk elektricitet. Använd speciell jordningsutrustning.

F Instructions de reparation

Veillez observer les prescriptions de sécurité en vigueur lors de dépannage !

Les connections par soudure doivent être consolidées par des oeillets lorsqu'elles sont soumises à des tensions importantes et à des contraintes mécaniques. De telles connections doivent toujours être faites à l'emplacement d'un oeillet.

Le câblage a un effet sur la sécurité et les perturbations électromagnétiques. Pour cette raison les câbles doivent garder leur position originale.

REGLEMENTATIONS RELATIVES AUX RAYONS X:

Le type du tube image et la haute tension maximale autorisée garantissent une intensité des rayons X du récepteur largement en deçà de la valeur autorisée. La tension ne doit pas dépasser la valeur indiquée sur la plaquette signalétique. La haute tension reste dans la fourchette autorisée lorsque la tension de service (U1) du niveau de déflexion horizontale est précise. Reportez-vous à la section "Réglages de service".

Avertissement DES

Le récepteur contient des composants qui sont sensibles aux décharges électrostatiques (DES). Toute opération de maintenance ou de réparation doit être effectuée dans un environnement où les composants ne seront pas exposés à des décharges électrostatiques. Utilisez un dispositif de mise à la terre spécial !

I Istruzioni di servizio

Osservare le norme di sicurezza vigenti in caso di riparazioni!

I punti di collegamento del circuito stampato che conducono un elevato valore di corrente o sono soggetti a stress meccanico, sono stati rinforzati mediante Rivetti. Tali parti rinforzanti devono rimanere sepre inseriti.

Il cablaggio puo' influenzare la sicurezza e la compatibilita' elettromagnetica (EMC) dell'apparecchio. Si raccomanda di mantenere il cablaggio nella posizione originale.

REGOLAMENTAZIONE DEI RAGGI-X:

Il tipo di tubo catodico unitamente all'uso del massimo livello di alta tensione consentito fanno sì che l'intensità dei raggi X del ricevitore rimanga molto al di sotto del valore consentito. Il valore della tensione elevata (EAT) non deve superare il limite indicato sul tagliando dell'apparecchio. L'alta tensione rientra nei limiti consentiti se la tensione operativa (U1) del livello di deflessione orizzontale è corretta. Fare riferimento alla sezione "Regolazioni di servizio".

Avvertenza ESD (scariche elettrostatiche)

Il ricevitore contiene componenti sensibili all'elettricità statica. Qualsiasi intervento di assistenza tecnica o riparazione deve essere eseguito in un ambiente in cui i componenti non possano essere soggetti a scariche elettrostatiche (ESD). A tal fine, usare uno specifico dispositivo di messa a terra!

Technical data	Technische Daten	Tekniska data	Données techniques	Dati tecnici	
System Multinorm ²⁾ NTSC	Norm Multinorm ²⁾ NTSC	Norm Multinorm-TV ²⁾ NTSC	Système Téléviseurs multinormes ²⁾ NTSC	Sistema Televisori multistandard ²⁾ NTSC	PAL/SECAM B, G PAL/SECAM B, G, D, K, K1, L, L', I 3.58/4.43 MHz via Scart
Mains power Consumption ¹⁾ In stand-by	Netzanschluß Leistungsaufnahme ¹⁾ Im Bereitschaft	Nätanslutning Effektförbrukning ¹⁾ I beredskapsläget	Alimentation Consommation ¹⁾ En mode veille	Tensione di alimentazione Consumo energetico ¹⁾ In standby	210...240 V, 50 Hz 135 W (normal) 0.2 W
Frequency range	Frequenzbereich	Frekvensområde	Gamme de fréquences	Campo di frequenza	48.25 - 855.25
Sound output (RMS) Surround channel ²⁾ Centre channel ²⁾ Subwoofer ²⁾	Tonendstufe (RMS) Surround ²⁾ Mitte ²⁾ Subwoofer ²⁾	Ljudeffekt (RMS) Surroundkanal ²⁾ Centrumkanal ²⁾ Subwoofer ²⁾	Sortie sonore (RMS) Canaux Surround ²⁾ Canal central ²⁾ Subwoofer ²⁾	Potenza audio (RMS) Canali Surround ²⁾ Canale centrale ²⁾ Subwoofer ²⁾	2 x 10 W/8 Ω 2 x 6 W/16 Ω 10 W/8 Ω 14 W/16 Ω
Connections on the front panel Headphones Audio/Video	Anschlüsse an der Vorderseite Kopfhöreranschluß Audio/Video	Anslutningar på framsidan Hörlurar Audio/Video	Connexions sur le panneau avant Ecouteurs Audio/Vidéo	Connessioni sul pannello frontale Cuffia Audio/Video	32...600 Ω, 3.5 mm Audio in: 0...2 V (RMS) Video in: 1 V/75 Ω Y/C in (SVHS)
Connections on the rear panel Audio/Video	Anschlüsse an der Rückseite Audio/Video	Anslutningar på baksidan Audio/Video	Connexions sur le panneau arrière Audio/Vidéo	Connessioni sul pannello posteriore Audio/Video	Audio in: 0...2 V (RMS) Audio out: 0...2 V/10 kΩ (RMS) Video in/out: 1 V/75Ω RGB in: 0.7 V/75Ω (E1, E3 ²⁾) Y/C in (SVHS) (E2)
External loudspeakers Surround loudspeakers ²⁾ Centre loudspeaker ²⁾	Externe Lautsprecher Surround-Lautsprecher ²⁾ Mitte-Lautsprecher ²⁾	Extrahögtalare Surroundhögtalare ²⁾ Centrumhögtalaren ²⁾	Haut-parleurs externes Haut-parleurs Surround ²⁾ Haut-parleurs Central ²⁾	Altoparlanti esterni Altoparlanti Surround ²⁾ Altoparlanti centrale ²⁾	min 10 W/8 Ω (RMS) min 6 W/16 Ω (RMS) min 10 W/8 Ω (RMS)
Antenna	Antennenanschluß	Antenn	Antenne	Antenna	75 Ω
Audio output ²⁾	Audio Ausgang ²⁾	Ljudutgångar ²⁾	Sortie audio ²⁾	Uscita audio ²⁾	0...2 V/10 kΩ (RCA)
VGA input ²⁾	VGA Eingang ²⁾	VGA ingång ²⁾	Entrée VGA ²⁾	Ingresso VGA ²⁾	640 x 480, 60 Hz 640 x 400, 70 Hz 640 x 350, 70 Hz
VGA audio input ²⁾	VGA Audio-Eingang ²⁾	VGA ljudingång ²⁾	Entrée audio VGA ²⁾	Ingresso audio VGA ²⁾	0...2 V (RMS) (RCA)
Specifications are subject to change.	Änderungen vorbehalten	Rätt till ändringar förbehålles.	Les Spécifications peuvent être modifiées sans préavis.	Le specifiche sono soggette a cambiamenti.	
¹⁾ Depends on option modules and picture tube. ²⁾ Not in all models.	¹⁾ Abhängig von Optionsmodulen und Bildröhre. ²⁾ Nicht in allen Modellen.	¹⁾ Varierar beroende på modul-upsättning och bildrör. ²⁾ Inte i alla modeller.	¹⁾ Dépend des modules optionnels et du tube cathodique. ²⁾ Pas sur tous les modèles.	¹⁾ A seconda dei moduli opzione e del tubo catodico. ²⁾ Non in tutti i modelli.	

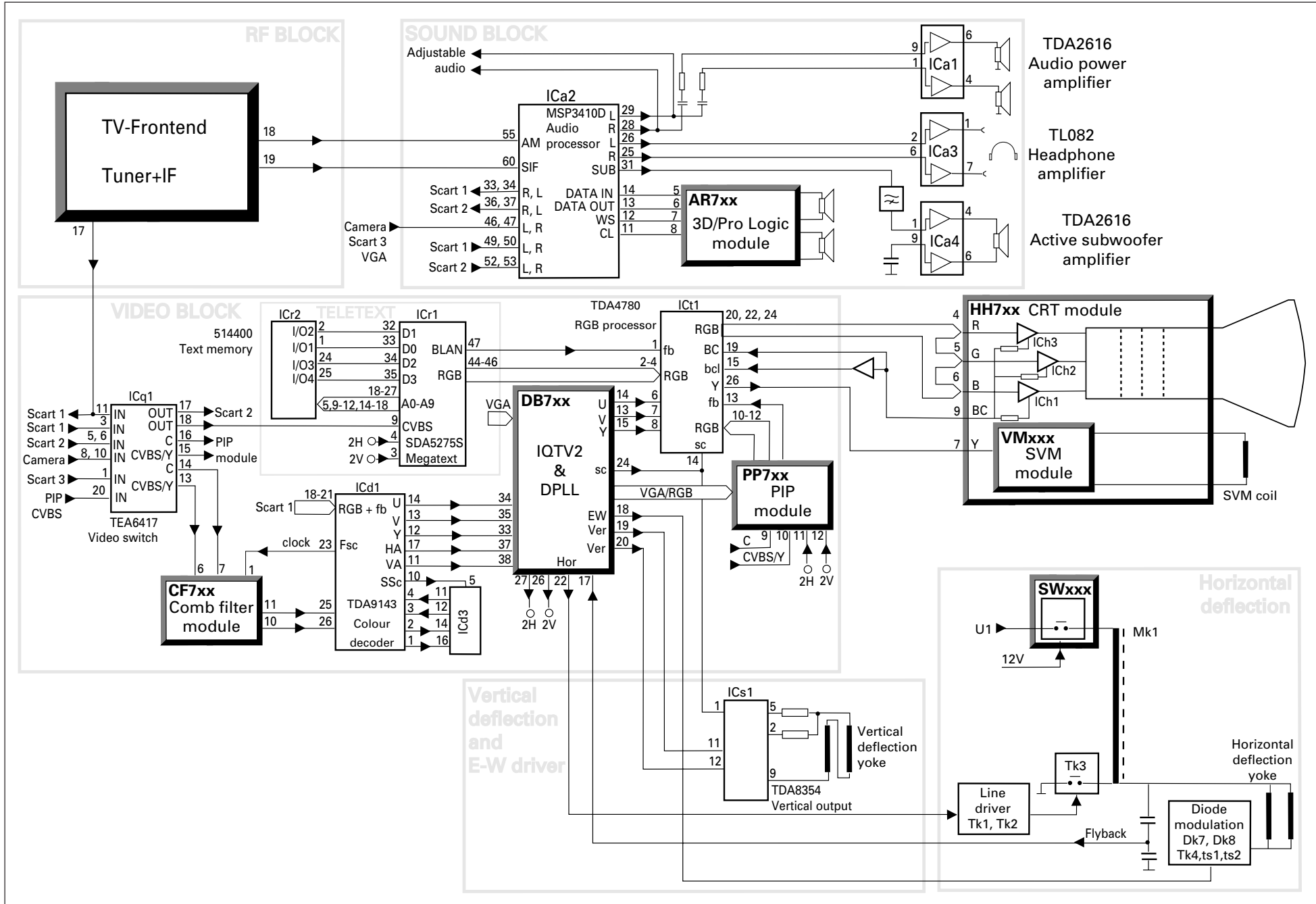

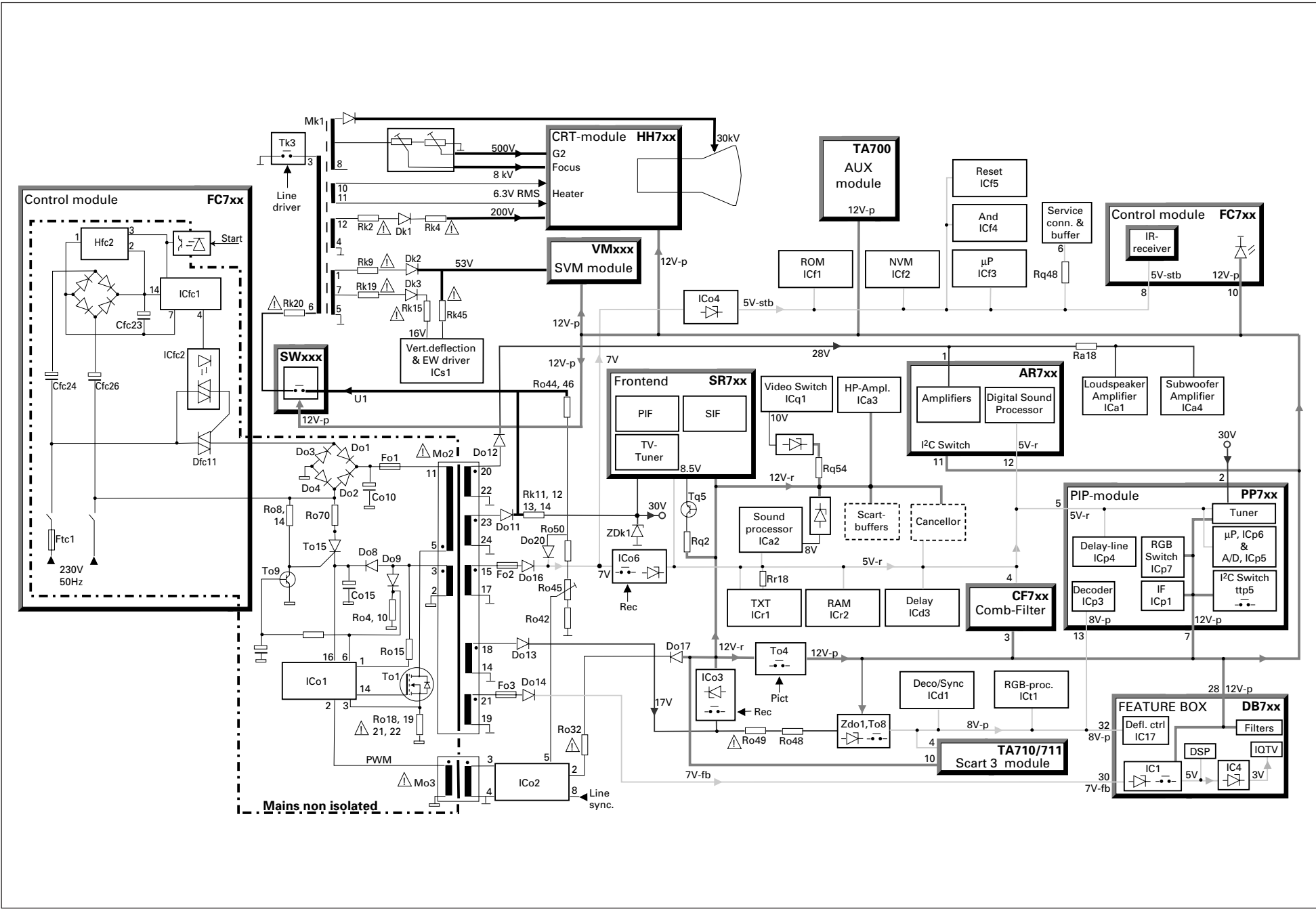

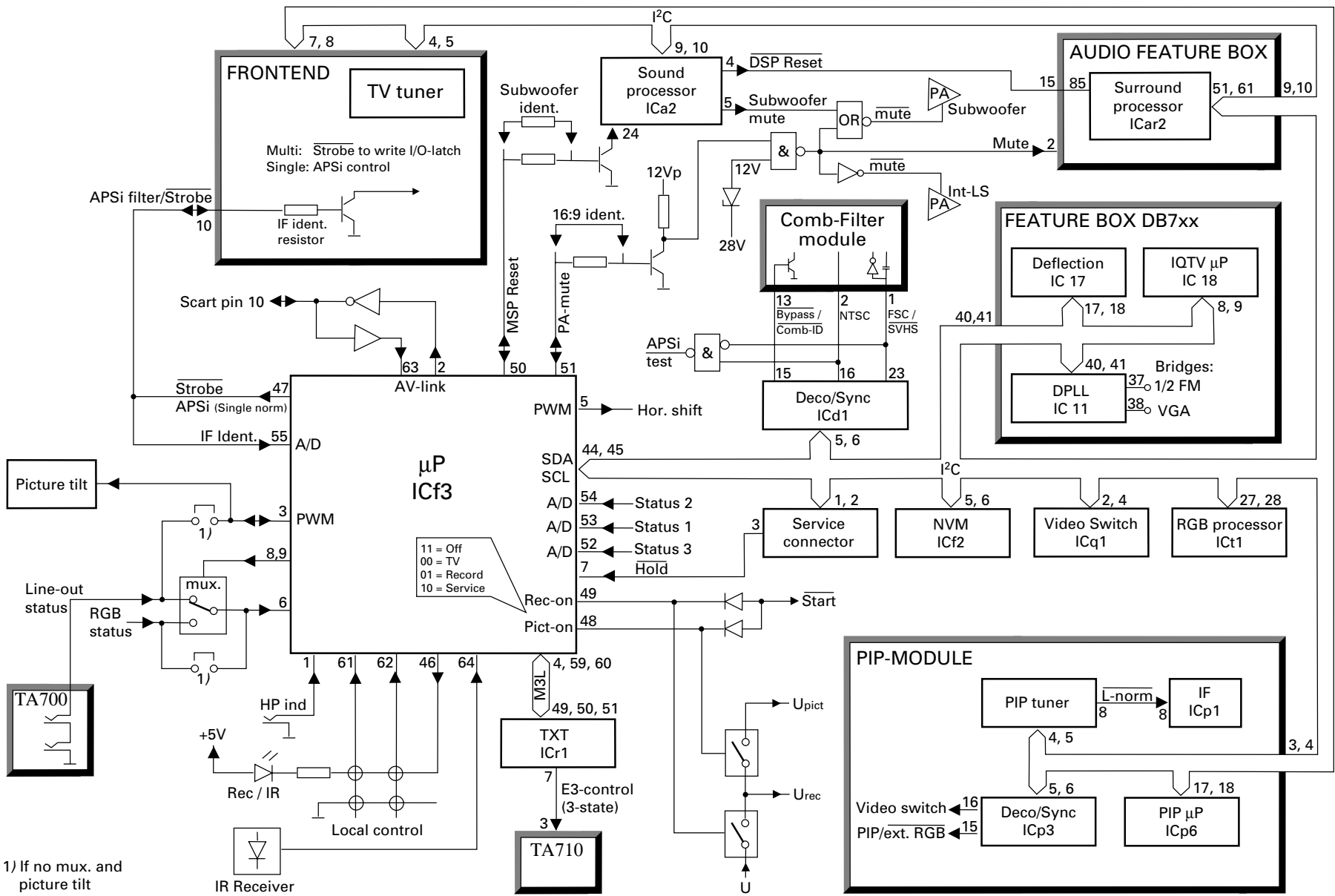

SCART connector

Pin	SCART 1	SCART 2	SCART 3 (Not in all models)
1	Audio out R, 0.5V (RMS)	Audio out R, 0.5V (RMS)	Audio out R, 0.5V (RMS)
2	Audio in R, 0.5V (RMS)	Audio in R, 0.5V (RMS)	Audio in R, 0.5V (RMS)
3	Audio out L, 0.5V (RMS)	Audio out L, 0.5V (RMS)	Audio out L, 0.5V (RMS)
4	Ground, audio	Ground, audio	Ground, audio
5	Ground, blue	Ground	Ground, blue
6	Audio in L, 0.5V (RMS)	Audio in L, 0.5V (RMS)	Audio in L, 0.5V (RMS)
7	RGB input, blue	S-video chrominance out (copy from front AV-connector)	RGB input, blue
8	Switching voltage 0 - 2V : no function 4.5 - 7V : 16/9 picture ratio 9.5 - 12V : normal picture ratio	Switching voltage 0 - 2V : no function 4.5 - 7V : 16/9 picture ratio 9.5 - 12V : normal picture ratio	Switching voltage 0 - 2V : no function 4.5 - 7V : 16/9 picture ratio 9.5 - 12V : normal picture ratio
9	Ground, green	Ground	Ground, green
10	-	AV-link bidirectional control logical 0: max 0.6V logical 1: min 3.7V	-
11	RGB input, green	-	RGB input, green
12	-	-	-
13	Ground, red	S-video ground (chrominance)	Ground, red
14	Ground	Ground	Ground
15	RGB input, red	S-video input (chrominance)	RGB input, red
16	Switching voltage, RGB blanking	-	Switching voltage, RGB blanking
17	Ground, video	Ground, video	Ground, video
18	Ground	Ground	Ground
19	Video out, 1 Vpp/75 Ω	Video out, 1 Vpp/75Ω S-video out (luminance)	Video out, 1 Vpp/75 Ω
20	Video in, 1 Vpp/75 Ω RGB sync in	Video in, 1 Vpp/75 Ω S-video in (luminance)	Video in, 1 Vpp/75 Ω RGB sync in
21	Screen	Screen	Screen

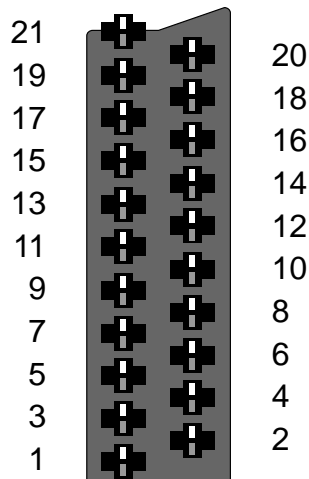

Operating instructions

Changing the menu language

1. Press the yellow button to select the Vision menu.
2. Press the red button to select the Display set-up menu.
3. Change the menu language with cursor buttons.
4. Press the OK button to store the changes.
5. Press the TV button to exit.

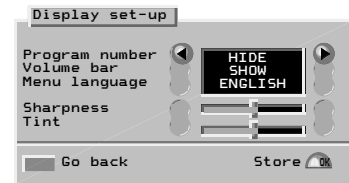

Manual tuning

1. Select the programme number you want to tune.
2. Press the MENU button.
3. Select "Tuning" and press the OK button.
4. Select "Manual tuning" and press the OK button.
5. Press the red button (Channel search).
6. Press the OK button to store.
7. Press the TV button to exit.

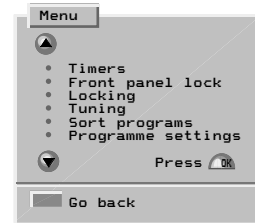

APSi (Automatic Programming System)

1. Press the MENU button.
2. Select "Tuning" and press the OK button.
3. Select "Automatic retuning" and press the OK button.
4. To retune the channels, press the red button.
5. Press the TV button to exit.

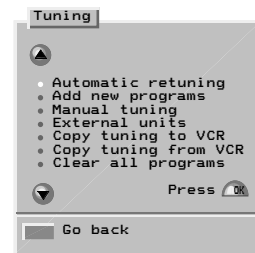

Selecting VGA input

1. Press the MENU button.
2. Select "Tuning" and press the OK button.
3. Select "External units" and press the OK button.
4. Select "VGA computer" and press the TV button.
(If "VGA computer" is not included in the list, select "Add new unit" by pressing the red button.)

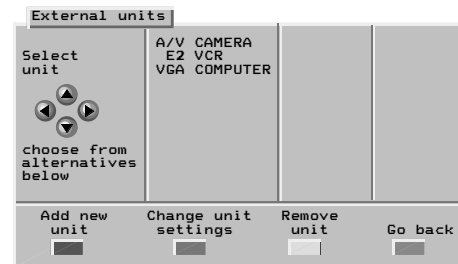

Initialization of NVRAM

Initialization of NVRAM (ICf2)

In case that the NVRAM is replaced, it must be initialized and configured.

1. Switch the TV set to stand-by mode.
Press \blacktriangleleft - (volume minus) button on local control unit and at the same time start entering password: MENU, TV and i with the remote control. Release \blacktriangleleft - button after the MENU button is pressed. The record led will light up to indicate that service mode is enabled.
2. Press the RED-button to pre-configure the set. Green led will flash once to indicate this.
- 3a. At the same time the controller will check NVRAM and initialize it automatically if it was "empty". Initializing will take about 15 s. When it is completed, the green led will light up. Continue to step 4.
- 3b. Automatic initialization did not happen if the green led does not light up steadily. In some cases the led might also light up immediately after configuration without any initializing, depending on NVRAM contents. In this case it might be enough to store the new configuration by pressing "OK". Continue to step 4.
- 3c. If automatic initialization did not happen, you can start it manually by entering the key code: BLUE (wait approx. 2 s.), 2, 5, 4 (wait approx. 2 s.) and OK. Initializing will take about 15 s.
4. Switch off the receiver by pressing the mains switch.
5. Start the receiver in TV mode by pressing the mains switch. Tune in one or more tv channels.
6. Switch off the receiver with remote control.
7. Enter service mode and make the service adjustments (see section "SERVICE ADJUSTMENTS VIA I²C BUS").
8. Switch off the receiver by pressing the mains switch.

Service adjustments

Service mode selection

1. Switch the TV set to stand-by mode.
2. Press \blacktriangleleft - (volume minus) button on local control unit and at the same time start entering password: MENU, TV and i with remote control. Release \blacktriangleleft - button after the MENU button is pressed. The record led will light up to indicate that service mode is enabled.
3. Switch on the receiver by pressing the TV button twice and select service mode by pressing the i button.

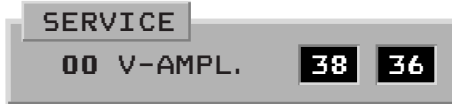

In service mode an adjustment menu is shown on the screen. The adjustment number and name, initializing (left) and adjustment (right) values are shown in the menu.

4. Exit service mode by switching off the receiver with the mains switch.

Configuration and fault diagnosis

The set must be configured after adding or removing some options. By pressing the RED button in service mode, the processor checks the configuration of the TV set and shows the settings on the screen. The configuration can be stored by pressing the OK button.

This feature can also be used in fault diagnosis. If an option bit is not '1' when it should be, the IC (or feature) is either not present or faulty.

Changing the option bytes

1. Select the configuration mode by pressing the RED button in service mode.

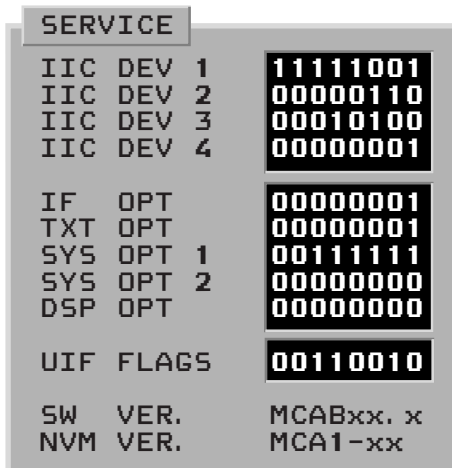

SW VER. = μ P software version.

NVM VER. = NVM software version.

2. Select IIC Device byte 1 - 4, Option byte 1 - 5 or uif flags byte with cursor button (up-/downwards). Selected byte is shown highlighted.
3. Set the bits with number buttons (0 ... 7).
4. Store the settings by pressing the OK button.
5. Return to normal service mode by pressing the RED button.

Option byte description

Bit	Description	7	6	5	4	3	2	1	0	'1'	'0'
IIC DEV 1 11111001											
0	TV tuner									Yes	No
1	IF Output, HEF4094									Yes	No
3	Decoder synch. processor, TDA9143									Yes	No
4	Deflection controller, TDA9151									Yes	No
5	RGB processor, TDA4780									Yes	No
6	IQTV processor									Yes	No
7	DPLL									Yes	No
IIC DEV 2 00000110											
0	VGA									Yes	No
1	Main video switch, TDA6417									Yes	No
2	Audio processor, MSP3410									Yes	No
3	16:9 picture tube									Yes	No
4	Comb filter									Yes	No
5	PIP processor, SDA9188 + TDA9141									Yes	No
6	PIP tuner									Yes	No
7	SCART 3 installed									Yes	No
IIC DEV 3 00010100											
0	Virtual sound (3D Sound)									Yes	No
1	Dolby processor									Yes	No
2	SDA30C264 processor									Yes	No
3	Subwoofer									Yes	No
4	Megatext, SDA5273/75									Yes	No
5	External text memory									Yes	No
6	Level 2.5 Megatext									Yes	No
7	One field memory (DB711 Module)									Yes	No
IIC DEV 4 00000001											
0	Nicam enabled									Yes	No
1	Control lead (Xata) to AR7xx module									Yes	No
IF OPT 00000001											
0	B/G system									Yes	No
1	I system									Yes	No
2	D/K system									Yes	No
3	L/L' system									Yes	No
TXT OPT 00000001											
0	Top enabled									Yes	No
1	Flof enabled									Yes	No
2	P26 disabled									Yes	No
3	Text sync mode									Yes	No
4	Automatic text subpage rolling									Yes	No
5	EPG (nexTVView) enabled									Yes	No
6	EPG record enabled									Yes	No
SYS OPT 1 00111111											
0	E0 (A/V connector) installed									Yes	No
1	E0 S-video									Yes	No
2	RGB enabled only in E1									Yes	No
3	ACI enabled									Yes	No
4	Micro power supply installed									Yes	No
5	Carrier mute enabled									Yes	No
SYS OPT 2 00000000											
0	Picture Tilt enabled									Yes	No
1	Autostart (Hotel TV)									Yes	No
7	Hotel TV functions enabled (manual)									Yes	No
UIF FLAGS 00110010											
0-2	Logo bit										
	000 = no logo, go direct to APSi										
	001 = no logo, go to language menu										
	010 = Akai logo										
	011 = Nokia logo										
	100 = Finlux logo										
	101 = Salora logo										
	110 = Luxor logo										
3	TV set not used before									Yes	No
4	Volume bar enabled									Yes	No
5	On screen programme number enabled									Yes	No
6	Front panel lock									Yes	No
7	Off timer active									Yes	No

Service adjustments via I²C-bus

Remote control buttons in service mode

When the receiver is in service mode you can select the normal TV mode by pressing the TV button and return to the service mode by pressing the i button. Number and cursor buttons are used for service adjustment. The OK button stores the settings.

Adjustment for different picture format

Make all adjustments with PAL signal unless otherwise mentioned. First make all adjustments with normal 4:3 picture format. Then make the necessary adjustments with other picture formats/signals. The required adjustments are shown in the table below.

Note! Check the configuration of the TV set before making the adjustments and make only the necessary adjustments.

Making the service adjustment

1. Give a two numbered code which determines the adjustment (e.g. 06 = width, see the following tables) with the number buttons. You can also select the adjustment with cursor buttons (up-/downwards).

SERVICE

06 WIDTH

49 33

2. Adjust with cursor buttons (left/right).

SERVICE

06 WIDTH

49 36

3. Store the new value by pressing the OK button.

Note!

- To avoid incomplete adjustments store each adjustment in the memory immediately after adjusting.
- If the adjustment has to be made separately for different picture format/signal, select the normal user mode by pressing the TV button and select the desired picture format/signal. Return to service mode by pressing the i button.

Picture geometry adjustments

Adjustment	Code	OSD name	classic (4:3)	wide movie	VGA 60 Hz	VGA 70 Hz	RGB	Note!
Vertical amplitude	00	V-AMPL.	X	X	X			
Vertical off-centre shift	01	V-SHIFT	X		X			
Vertical start scan	02	V-START	X		X	X		
Vertical S-correction	03	S-CORR.	X	X	X			
Vertical slope (coarse)	04	SLOPE-H	X		X	X		Adjust also with NTSC signal.
Vertical slope (fine)	05	SLOPE-L	X					Adjust also with NTSC signal.
Width	06	WIDTH	X		X	X		
Horizontal shift deflection	07	H-SHIFT	X					Not in all sets.
Horizontal phase video	08	PHASE	X		X	X	X	
Parabola	09	PARABOLA	X	X	X			
Corner	10	CORNER	X	X	X			
Trapezium	11	TRAPEZIUM	X		X			
EHT compensation	12	EHT	X		X			Set brightness and contrast to 90% and compensate the change in picture size.

VGA 60 Hz = Windows mode

VGA 70 Hz = DOS mode

Other adjustments

Adjustment	Code	OSD name	Note!
Red reference	18	R REF.	This procedure is necessary e.g. when the picture tube, CRT-module etc. has been replaced. Apply a test picture and adjust the R, G and B references. Then adjust the R, G and B gains.
Green reference	19	G REF.	
Blue reference	20	B REF.	
Red gain	15	R GAIN	
Green gain	16	G GAIN	
Blue gain	17	B GAIN	
Peak white limit	21	PWL	Normally no need to adjust.
Luma delay	14	LUMA DELAY	Separate adjustment for Video, PAL BG, PAL DK/I and Secam L.

Service adjustments

O Power supply block

Supply voltage and protection circuit

1. Set brightness and contrast to normal level. Connect a universal voltmeter to the cathode of Do11.
2. Adjust the U1 voltage with Ro45. The voltage depends on the picture tube type, refer to the section "Variable components".
3. Check the over-current protection after making any service operations in the primary circuit of the power supply. Activate the service mode and then switch the set to stand-by mode. Short circuit the cathode of Do13 to the ground and keep the short circuit connected. When the over-current protection works correctly, the power supply will try to start 2-3 times before it stops permanently. Remove the short circuit and switch on the receiver by pressing the mains button.

SR Tuner/IF module (Frontend)

Tuner AGC

The tuner AGC is adjusted with a potentiometer through a hole in the heat sink (see picture below). Apply a 1 mV (60 dB μ V) test signal and adjust the picture just without noise.

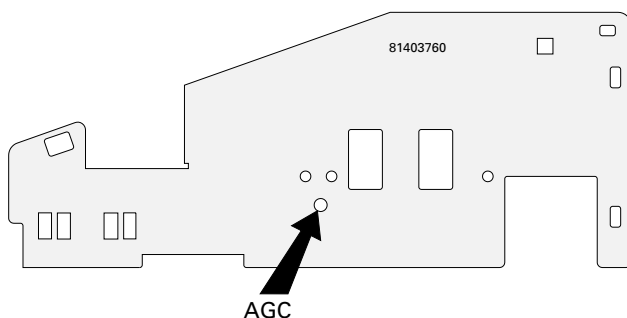

K Horizontal deflection block

Horizontal linearity

Adjust with Lk2.

Focusing

Set brightness and contrast to normal level. Use crosshatch pattern and adjust the picture for optimum resolution.

(Screen grid voltage) Ug2 voltage

1. Set brightness and colour saturation to normal level and contrast to minimum.
2. At the end of the vertical blanking, there is a black current measurement pulse (clamp pulse) at pin 9 of ICh1, ICh2 and ICh3. Use an oscilloscope and find the output stage with the highest cut-off (i.e. the highest voltage during the black current measurement pulse).
3. Adjust the voltage of the clamp pulse to +140 V with Ug2 (see figure).

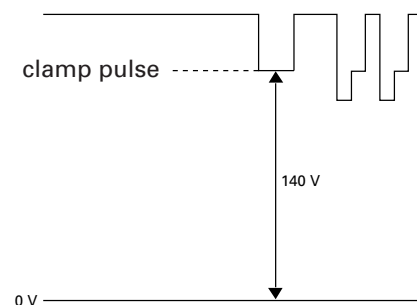

Note! Adjust the voltage with a clamp pulse.

Bedienungsanleitung

Ändern der Menüsprache

1. Drücken Sie die gelbe Taste zur Wahl des Bildmenüs.
2. Drücken Sie die rote Taste zur Wahl des Anzeige-Optionen-Menüs.
3. Ändern Sie die Menü Sprache mit den Cursortasten.
4. Drücken Sie zum Speichern der Änderungen die OK-Taste.
5. Drücken Sie zum Verlassen des Menüs die TV-Taste.



Manuelle Abstimmung

1. Wählen Sie die Programmnummer, die Sie abstimmen möchten.
2. Drücken Sie die MENU-Taste.
3. Wählen Sie "Abstimmung" und drücken Sie die OK-Taste.
4. Wählen Sie "Senderabstimmung" und drücken Sie die OK-Taste.
5. Drücken Sie die rote Taste (Kanal-Suchlauf).
6. Drücken Sie zum Speichern die OK-Taste.
7. Drücken Sie zum Verlassen des Menüs die TV-Taste.

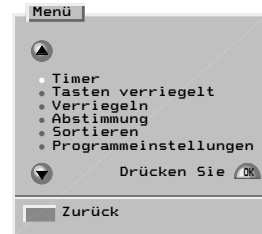

APSi (Automatisches Programmiersystem)

1. Drücken Sie die MENU-Taste.
2. Wählen Sie "Abstimmung" und drücken Sie die OK-Taste.
3. Wählen Sie "Neuprogrammierung" und drücken Sie die OK-Taste.
4. Drücken Sie zur Neuabstimmung der Kanäle die rote Taste.
5. Drücken Sie zum Verlassen des Menüs die TV-Taste.

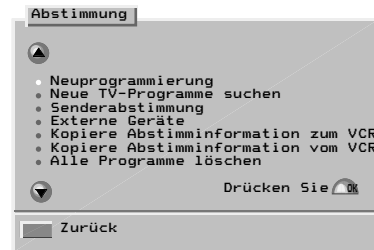

Wahl des VGA-Eingangs

1. Drücken Sie die MENU-Taste.
2. Wählen Sie "Abstimmung" und drücken Sie die OK-Taste.
3. Wählen Sie "Externe Geräte" und drücken Sie die OK-Taste.
4. Wählen Sie "VGA Computer" und drücken Sie die OK-Taste. (Falls "VGA Computer" nicht in der Liste enthalten ist, wählen Sie "Neues Gerät hinzufügen" durch Drücken der roten Taste.)

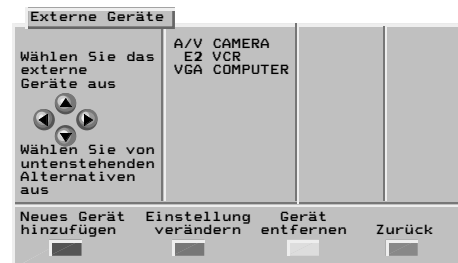

Initialisierung des NVRAM

Initialisierung des NVRAM (ICf2)

Im Falle eines Austausches des NVRAM muß dieser initialisiert und konfiguriert werden.

1. Schalten Sie das Fernsehgerät in die Betriebsbereitschaft.
Drücken Sie die \blacktriangleleft -Taste (Lautstärke-Minus) an der Bedieneinheit, während Sie gleichzeitig die Eingabe des Paßwortes mit der Fernbedienung starten: MENU, TV und i. Lassen Sie die \blacktriangleleft -Taste los, nachdem die MENU-Taste gedrückt wurde. Die Aufnahme-LED leuchtet auf und zeigt an, daß der Servicemodus aktiviert ist.
2. Drücken Sie zur Vorkonfiguration des Fernsehgerätes die rote Taste. Die grüne LED leuchtet zur Kontrolle einmal auf.
- 3a. Zur gleichen Zeit überprüft der Controller den NVRAM und initialisiert ihn automatisch, wenn er "leer" war. Die Initialisierung dauert ungefähr 15 Sekunden. Wenn sie durchgeführt worden ist, leuchtet die grüne LED auf. Fahren Sie mit Schritt 4 fort.
- 3b. Die automatische Initialisierung wurde nicht durchgeführt, wenn die grüne LED nicht dauernd aufleuchtet. In manchen Fällen kann die LED direkt nach

- der Konfiguration ohne jede Initialisierung aufleuchten, abhängig vom Inhalt des NVRAM. In diesem Fall ist es ausreichend, die neue Konfiguration durch Drücken der OK-Taste zu speichern. Fahren Sie mit Schritt 4 fort.
- 3c. Ist die automatische Initialisierung nicht durchgeführt worden, kann diese manuell durch Eingabe des Schlüsselcodes gestartet werden: BLAUE (ca. 2 Sekunden warten), 2, 5, 4 (ca. 2 Sekunden warten) und OK. Die Initialisierung dauert ungefähr 15 Sekunden
4. Schalten Sie das Fernsehgerät durch Drücken des Netzschalters aus.
5. Schalten Sie das Fernsehgerät durch Drücken des Netzschalters in den Fernsehbetrieb. Stellen Sie einen oder mehrere Kanäle ein.
6. Schalten Sie das Fernsehgerät mit der Fernbedienung aus.
7. Gehen Sie in den Servicemodus und nehmen Sie die Service-Einstellungen vor (siehe Abschnitt "SERVICE-EINSTELLUNGEN ÜBER DEN I²C-BUS").
8. Schalten Sie das Fernsehgerät mit dem Netzschalter aus.

Service-Einstellungen

Wahl des Servicemodus

- Schalten Sie das Fernsehgerät in die Betriebsbereitschaft.
- Drücken Sie die \blacktriangleleft -Taste (Lautstärke-Minus) an der Bedieneinheit, während Sie gleichzeitig die Eingabe des Paßwortes mit der Fernbedienung starten: MENU, TV und i. Lassen Sie die \blacktriangleleft -Taste los, nachdem die MENU-Taste gedrückt wurde. Die Aufnahme-LED leuchtet auf und zeigt an, daß der Servicemodus aktiviert ist.
- Schalten Sie das Fernsehgerät durch zweimaliges Drücken der TV-Taste ein und wählen Sie den Servicemodus durch Drücken der i-Taste.



Im Servicemodus wird ein Einstellmenü auf dem Bildschirm gezeigt. Die Einstellungszahl und der Name, die Initialisierung (links) und die Einstellwerte (rechts) werden in diesem Menü gezeigt.

- Verlassen Sie den Servicemodus durch Ausschalten des Fernsehgerätes mit dem Netzschalter.

Konfiguration und Fehlerdiagnose

Nach Hinzufügen oder Entfernen von Optionen muß das Fernsehgerät konfiguriert werden. Durch Drücken der roten Taste im Servicemodus überprüft der Prozessor die Konfiguration des Fernsehgerätes und zeigt die Einstellungen auf dem Bildschirm an. Die Konfiguration kann durch Drücken der OK-Taste gespeichert werden.

Dieses Feature kann auch bei der Fehlerdiagnose benutzt werden. Wenn ein Option-Bit nicht '1' ist - was dieses aber sein sollte - ist der IC (oder das Feature) entweder nicht vorhanden oder defekt.

Änderung der Options-Bytes

- Wählen Sie den Konfigurationsmodus durch Drücken der roten Taste im Servicemodus.

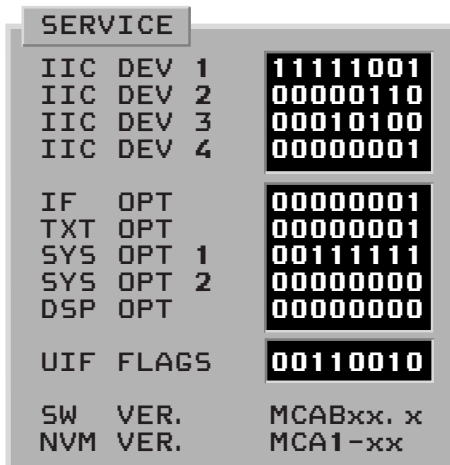

SW VER. = μ P Softwareversion.

NVM VER. = NVM Softwareversion.

- Wählen Sie das IIC-Gerätebyte 1 -4, das Prüfbyte 1 - 5 oder das uif-Kennzeichenbyte mit den Cursortasten (auf-/abwärts). Das gewählte Byte wird hervorgehoben dargestellt.
- Stellen Sie die Bits mit den Zifferntasten (0 ... 7) ein.
- Speichern Sie die Einstellungen durch Drücken der OK-Taste.
- Kehren Sie durch Drücken der roten Taste zum normalen Servicemodus zurück.

Beschreibungen der Options-Bytes

Bit	Beschreibung	7	6	5	4	3	2	1	0	'1'	'0'
IIC DEV 1 11111001											
0	TV-Tuner									Ja	Nein
1	IF-Ausgang, HEF4094									Ja	Nein
3	Synchronprozessor Decoder, TDA9143									Ja	Nein
4	Ablenkungssteuerung, TDA9151									Ja	Nein
5	RGB-Prozessor, TDA4780									Ja	Nein
6	IQTV-Prozessor									Ja	Nein
7	DPLL									Ja	Nein
IIC DEV 2 00000110											
0	VGA Option installiert									Ja	Nein
1	Hauptvideoschalter, TDA6417									Ja	Nein
2	Tonprozessor, MSP3410									Ja	Nein
3	16:9 Bildröhre									Ja	Nein
4	Kammfilter installiert									Ja	Nein
5	PIP-Prozessor, SDA9188 + TDA9141									Ja	Nein
6	PIP-Tuner									Ja	Nein
7	SCART 3 installiert									Ja	Nein
IIC DEV 3 00010100											
0	Virtueller 3D Ton									Ja	Nein
1	Dolby-Prozessor									Ja	Nein
2	SDA30C264-Prozessor									Ja	Nein
3	Subwoofer installiert									Ja	Nein
4	Megatext, SDA5273/75									Ja	Nein
5	VT mit externen RAM									Ja	Nein
6	Level 2.5 Megatext									Ja	Nein
7	Einfeld-Speicher (DB711 Modul)									Ja	Nein
IIC DEV 4 00000001											
0	Nicam aktiviert									Ja	Nein
1	Steuerleitung (Xata) an AR7xx-Modul									Ja	Nein
IF OPT 00000001											
0	B/G-System									Ja	Nein
1	I-System									Ja	Nein
2	D/K-System									Ja	Nein
3	L/L'-System									Ja	Nein
TXT OPT 00000001											
0	Toptext aktiviert									Ja	Nein
1	Floftext aktiviert									Ja	Nein
2	TXT packet P26 nicht aktiviert									Ja	Nein
3	Text-Synchronmodus									Ja	Nein
4	Autom. Weiterblättern von Textunterseiten									Ja	Nein
5	EPG (nexTView) aktiviert									Ja	Nein
6	EPG-Aufnahme aktiviert									Ja	Nein
SYS OPT 1 00111111											
0	E0 (A/V-Anschluß) installiert									Ja	Nein
1	E0 S-Video									Ja	Nein
2	RGB nur möglich bei E1									Ja	Nein
3	ACI aktiviert									Ja	Nein
4	Micro Power Netzteil installiert									Ja	Nein
5	Tonträger Steuerschaltung									Ja	Nein
SYS OPT 2 00000000											
0	Bilddrehung aktiviert									Ja	Nein
1	Autostart (Hotel TV)									Ja	Nein
7	Hotel TV-Funktionen aktiviert (manuell)									Ja	Nein
UIF FLAGS 00110010											
0-2	Logo-Bit										
	000 = Kein Logo, direkt in das APSi gehen										
	001 = Kein Logo, in das Sprachmenü gehen										
	010 = Akai-Logo										
	011 = Nokia-Logo										
	100 = Finlux-Logo										
	101 = Salora-Logo										
	110 = Luxor-Logo										
3	Fernsehgerät zuvor noch nicht benutzt									Ja	Nein
4	Lautstärkebalken aktiviert									Ja	Nein
5	Einblendung Programmnummer aktiviert									Ja	Nein
6	Verriegelung der Tasten am Gerät									Ja	Nein
7	Off-Timer aktiv									Ja	Nein

Service-Einstellungen über I²C-bus

Tasten der Fernbedienung im Servicemodus

Wenn sich das Fernsehgerät im Servicemodus befindet, können Sie den normalen Fernsehmodus durch Drücken der TV-Taste wählen. Sie können durch Drücken der i-Taste zum Servicemodus zurückkehren. Ziffern- und Cursortasten werden zur Service-Einstellung benötigt. Die OK-Taste speichert die Einstellungen.

Einstellungen für ein anderes Bildformat

Wenn nicht anders vermerkt, nehmen Sie alle Einstellungen mit dem PAL-Signal vor. Führen Sie zuerst alle Einstellungen mit dem normalen 4:3 Bildformat durch. Führen Sie dann die notwendigen Einstellungen mit anderen Bildformaten bzw. Signalen durch. Die erforderlichen Einstellungen werden in der unten befindlichen Tabelle gezeigt.

Hinweis! Überprüfen Sie die Konfiguration des Fernsehgerätes, bevor Sie die Einstellungen vornehmen; nehmen Sie nur die nötigen Einstellungen vor.

Service-Einstellung vornehmen

1. Geben Sie mit den Zifferntasten den zweistelligen Code ein, der die Einstellung bestimmt (z.B. 06 = Bildbreite, siehe folgende Tabellen). Sie können die Einstellung auch mit den Cursortasten wählen (auf-/abwärts).

SERVICE

06 WIDTH

49 33

2. Nehmen Sie die Einstellung mit den Cursortasten (links/rechts) vor.

SERVICE

06 WIDTH

49 36

3. Speichern Sie den neuen Wert durch Drücken der OK-Taste.

Hinweis!

- Um unvollständige Einstellungen zu vermeiden, speichern Sie jede Einstellung direkt nach dem Einstellen ab.
- Falls die Einstellung getrennt für verschiedene Bildformate bzw. Signale durchgeführt werden muß, gehen Sie durch Drücken der TV-Taste in den normalen Betriebsmodus und wählen Sie das gewünschte Bildformat bzw. Signal. Gehen Sie durch Drücken der i-Taste in den Servicemodus zurück.

Einstellungen der Bildgeometrie

Einstellung	Code	OSD Bezeichn.	Classic	Movie (weit)	VGA 60 Hz	VGA 70 Hz	RGB	Hinweis!
Vertikale Amplitude	00	V-AMPL.	X	X	X			
Vertikale Lage	01	V-SHIFT	X		X			
Vertikale Start-Zeile	02	V-START	X		X	X		
Vertikale S-Korrektur	03	S-CORR.	X	X	X			
Vertikale Steilheit (grob)	04	SLOPE-H	X		X	X		Auch mit dem NTSC-Signal einstellen.
Vertikale Steilheit (fein)	05	SLOPE-L	X					Auch mit dem NTSC-Signal einstellen.
Bildbreite	06	WIDTH	X		X	X		
Horizontale Lage der Ablenkung	07	H-SHIFT	X					Nicht in allen Geräten.
Horizontale Lage Video	08	PHASE	X		X	X	X	
OW-Kissen	09	PARABOLA	X	X	X			
OW-Ecken Korrektur	10	CORNER	X	X	X			
OW-Trapez	11	TRAPEZIUM	X		X			
EHT-Kompensation	12	EHT	X		X			Stellen Sie Helligkeit und Kontrast auf 90% ein und kompensieren Sie die Änderung der Bildgröße.

VGA 60 Hz = Windows-Modus

VGA 70 Hz = DOS-Modus

Weitere Einstellungen

Einstellungen	Code	OSD Bezeichn.	Hinweis!
Rot-Referenz	18	R REF.	Dieser Vorgang ist notwendig, wenn z.B. die Bildröhre, das CRT-Modul usw. ausgetauscht worden sind. Schalten Sie zu einem Testbild und stellen Sie die R-, G- und B-Referenzen ein. Stellen Sie anschließend die R-, G- und B-Verstärkungen ein.
Grün-Referenz	19	G REF.	
Blau-Referenz	20	B REF.	
Rotverstärkung	15	R GAIN	
Grünverstärkung	16	G GAIN	
Blauverstärkung	17	B GAIN	
Oberer Grenzwert weiß	21	PWL	Braucht normalerweise nicht eingestellt zu werden.
Y-Verzögerungsleitung	14	LUMA DELAY	Getrennte Einstellung für Video, PAL BG, PAL DK/I und SECAM L.

Service-Einstellungen

O Netzteil

Versorgungsspannung und Schutzschaltung

1. Stellen Sie Helligkeit und Kontrast auf den normalen Wert ein. Schließen Sie ein Universalvoltmeter an die Kathode von Do11 an.
2. Stellen Sie die Spannung U1 mit Ro45 ein. Die Spannung hängt vom Bildröhrentyp ab, siehe auch Abschnitt "Röhrenabhängige Bauteile".
3. Prüfen Sie den Überstromschutz nach Durchführung von Servicearbeiten im primären Schaltkreis der Stromversorgung. Aktivieren Sie den Servicemodus und schalten Sie dann das Fernsehgerät in die Betriebsbereitschaft. Schließen Sie die Kathode von Do13 an Masse kurz und lassen Sie die Kurzschlußverbindung bestehen. Wenn der Überstromschutz richtig arbeitet, versucht die Stromversorgung 2 - 3 mal zu starten, bevor sie unterbricht. Entfernen Sie die Kurzschlußschaltung und schalten Sie das Fernsehgerät durch Drücken des Netzschalters ein.

SR Tuner/ZF Modul (Frontend)

AGC-Tuner

Die AGC Regelung des Tuners wird mit einem Potentiometer durch eine Öffnung im Kühlkörper (siehe Bild unten) eingestellt. Geben Sie ein Testsignal von 1 mV (60 dB μ V) und stellen Sie das Bild genau ohne Rauschen ein.

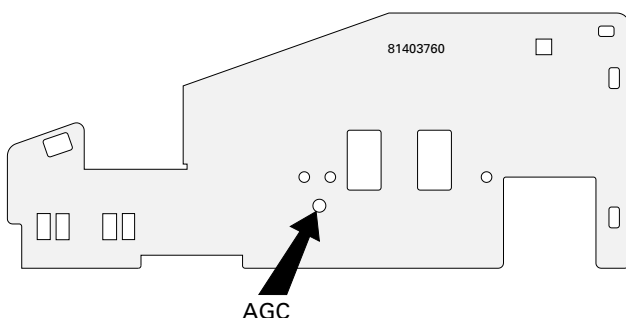

K Horizontal-Ablenkeinheit

Horizontale Linearität

Mit Lk2 einstellen.

Fokussierung

Stellen Sie Helligkeit und Kontrast auf den normalen Wert ein. Benutzen Sie ein Kreuzschraffurmuster und stellen Sie das Bild auf die optimale Auflösung ein.

(Schirmgitterspannung) Spannung Ug2

1. Stellen Sie Helligkeit und Farbsättigung auf den normalen Wert und den Kontrast auf den kleinsten Wert ein.
2. Am Ende des vertikalen Austastens ist ein Schwarzstrom-Meßimpuls (Klemmimpuls) an Pin 9 von ICh1, ICh2 und ICh3. Verwenden Sie ein Oszilloskop und ermitteln Sie die Ausgangsstufe mit dem höchsten Grenzwert (z.B. die höchste Spannung während des Schwarzstrom-Meßimpulses).
3. Stellen Sie die Spannung des Klemmimpulses mit Ug2 auf +140 V ein (siehe Abbildung).

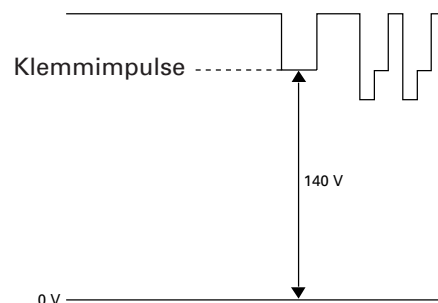

Hinweis! Die Spannung auf die Klemmimpulse einzustellen.

Bruksanvisning

Ändra menyspråk

1. Välj "Önskebild"-menyn med den GULA knappen.
2. Tryck på den RÖDA knappen för att välja Display inställningar.
3. Ändra menyspråk med markörknapparna.
4. Spara inställningen med OK-knappen.
5. Lämna menyn med TV-knappen.

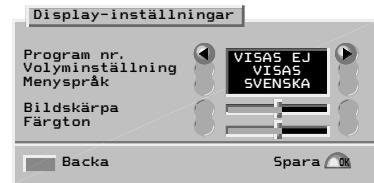

Manuell avstämning

1. Välj programplatsen du vill ställa in.
2. Tryck på MENU-knappen.
3. Välj "Söka program" och tryck på OK-knappen.
4. Välj "Söka manuellt" och tryck på OK-knappen.
5. Tryck på den röda (Kanalsökning) knappen.
6. Tryck på OK-knappen för att spara.
7. Lämna menyn med TV-knappen.

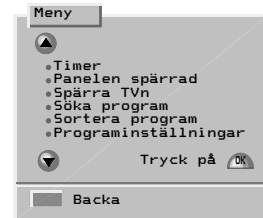

APSi (Automatic Programming System)

1. Tryck på MENU-knappen.
2. Välj "Söka program" och tryck på OK-knappen.
3. Välj "Automatisk sökning på nytt" och tryck på OK.
4. För att omprogrammera programmen, tryck på den RÖDA knappen.
5. Lämna menyn med TV-knappen.

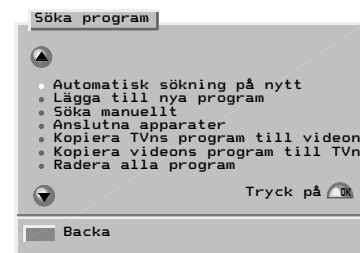

Val av VGA-ingång

1. Tryck på MENU-knappen.
2. Välj "Söka program" och tryck på OK-knappen.
3. Välj "Anslutna apparater" och tryck på OK-knappen.
4. Välj "VGA Computer" och tryck på TV-knappen.
(Om inte "VGA Computer" ingår i listan, välj "Lägg till ny apparat" med den RÖDA knappen.)

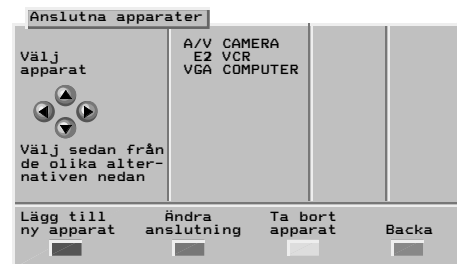

Initialisering av NVRAM

Initialisering av NVRAM (ICf2)

Efter byte av NVRAM-minnet måste det initialiseras och konfigureras.

1. Ställ mottagaren i beredskapsläge.
Håll frontpanelens (volym minus) knapp intryckt och tryck samtidigt på fjärrkontrollens MENU, TV och "i" knappar. Frigör -knappen efter att MENU-knappen är intryckt. Inspelningslampan börjar lysa för att indikera serviceläge.
2. Tryck på den röda färgknappen för att förkonfigurera apparaten. Den gröna lysdioden blinkar till.
- 3a. NVRAM-minnet kontrolleras samtidigt och initialiseras om det var "tomt". Initialiseringen tar ca. 15 s. När initialiseringen är utförd, börjar den gröna lysdioden lysa. Fortsätt från punkt 4.
- 3b. Om den gröna lysdioden inte börjar lysa kontinuerligt, blev automatisk initialisering inte utförd. Beroende på NVRAM-minnets innehåll kan lysdioden också börja lysa direkt efter konfigurering, utan att det initialiseras. I detta fall kan det räcka med att spara konfigureringen genom att trycka på OK-knappen och fortsätta med punkt 4.
- 3c. Startas inte automatisk initialisering, kan du starta den manuellt med följande knappsekvens: BLÅ (vänta ca. 2 s.), 2, 5, 4 (vänta ca. 2 s.) och OK. Initialiseringen tar ca. 15 sekunder.
4. Stäng av mottagaren med huvudströmbrytaren.
5. Ställ mottagaren i normalt tv-läge genom att slå på den med huvudströmbrytaren. Ställ in ett eller flera TV-program.
6. Stäng av mottagaren med huvudströmbrytaren.
7. Välj serviceläge och gör alla serviceinställningar (se avsnitt "SERVICEINSTÄLLNINGAR VIA I²C-BUS").
8. Stäng av mottagaren med huvudströmbrytaren.

Serviceinställningar

Val av serviceläge

1. Ställ mottagaren i beredskapsläge.
2. Tryck **◀**- (volym minus) knappen på frontpanelen och tryck samtidigt in knappsekvens MENU, TV och "i" med fjärrkontrollen. Frigör **◀**- knappen efter att MENU-knappen är intryckt. Inspelningslampan börjar lysa för att indikera serviceläge.
3. Slå på mottagaren genom att trycka två gånger på TV-knappen och välj serviceläge med i-knappen.



I serviceläge visas SERVICE-menyn. På den visas justeringens nummer och namn, initialiserings- (vänster) och justerings- (höger) värden.

4. Lämna serviceläge genom att stänga av tv:n med huvudströmbrytaren.

Konfigurering och felsökning

TV:n måste konfigureras när man gör ingrepp som ändrar apparatens egenskaper. När man i serviceläge trycker på den RÖDA knappen, kontrollerar processorn tv:ns konfiguration och visar den på bildskärmen. Konfigurationen kan sparas genom att trycka på OK-knappen.

Denna funktion kan också användas till felsökning. Är en optionbit inte "1" när den skall vara det är IC:n (eller tillsatsen) inte monterad eller defekt.

Ändring av optionbit

1. I serviceläge välj konfigureringsläge genom att trycka på den RÖDA knappen.

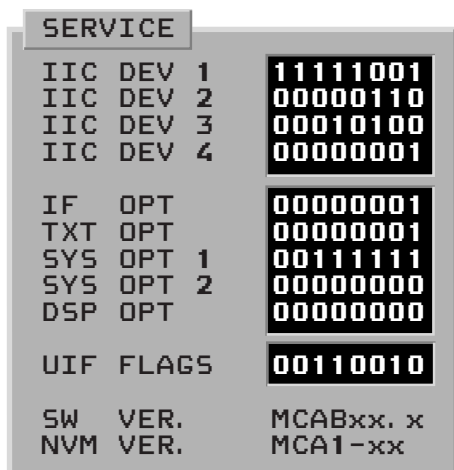

SW VER. = μ P programversion
NVM VER. = NVM programversion

2. Välj IIC Device byte 1-4, Option byte 1-5 eller uif flags byte med markörknapparna (upp-/nedåt). Vald byte visas med komplementfärg.
3. Ställ in bittarna med sifferknapparna (0...7).
4. Spara inställningen med OK-knappen.
5. Återgå till normalt serviceläge med den RÖDA knappen.

Option byte förklaring

Bit	Förklaring	7	6	5	4	3	2	1	0	'1'	'0'
IIC DEV 1 11111001											
0	TV tuner									Ja	Nej
1	MF Output, HEF4094									Ja	Nej
3	Dekoder, TDA9143									Ja	Nej
4	Avlänkningskontroller, TDA9151									Ja	Nej
5	RGB processor, TDA4780									Ja	Nej
6	IQTV processor									Ja	Nej
7	DPLL									Ja	Nej
IIC DEV 2 00000110											
0	VGA									Ja	Nej
1	Videoswitch, TDA6417									Ja	Nej
2	Ljudprocessor, MSP3410									Ja	Nej
3	16:9 bildrör									Ja	Nej
4	Comb-filter									Ja	Nej
5	PIP processor, SDA9188 + TDA9141									Ja	Nej
6	PIP tuner									Ja	Nej
7	SCART 3 installerad									Ja	Nej
IIC DEV 3 00010100											
0	Virtual ljud (3D Sound)									Ja	Nej
1	Dolby processor									Ja	Nej
2	SDA30C264 processor									Ja	Nej
3	Subwoofer									Ja	Nej
4	Megatext, SDA5273/75									Ja	Nej
5	TEXT med yttre RAM									Ja	Nej
6	Nivå 2.5 Megatext									Ja	Nej
7	En fälts minne (DB711 Modul)									Ja	Nej
IIC DEV 4 00000001											
0	Nicam									Ja	Nej
1	Kontrollledning (Xata) till AR7xx modul									Ja	Nej
IF OPT 00000001											
0	B/G-norm									Ja	Nej
1	I-norm									Ja	Nej
2	D/K-norm									Ja	Nej
3	L/L'-norm									Ja	Nej
TXT OPT 00000001											
0	TOP-text									Ja	Nej
1	FLOF-text									Ja	Nej
2	P26									Ja	Nej
3	Textsynk läge									Ja	Nej
4	Rullning av flersidor									Ja	Nej
5	EPG (nexTVView)									Ja	Nej
6	EPG inspänning									Ja	Nej
SYS OPT 1 00111111											
0	E0 (A/V kontakter) installerade									Ja	Nej
1	E0 S-video									Ja	Nej
2	RGB endast möjligt i E1									Ja	Nej
3	ACI									Ja	Nej
4	Mikro power installerad									Ja	Nej
5	Bärvågsdämpning									Ja	Nej
SYS OPT 2 00000000											
0	Bildlutning möjligt									Ja	Nej
1	Autostart (Hotel-TV)									Ja	Nej
7	Hotel-TV funktioner (manuellt)									Ja	Nej
UIF FLAGS 00110010											
0-2	Logo bit										
	000 = ingen logo, gå direkt till APSi										
	001 = ingen logo, gå till språk menu										
	010 = Akai logo										
	011 = Nokia logo										
	100 = Finlux logo										
	101 = Salora logo										
	110 = Luxor logo										
3	Ny TV (fabriksny)									Ja	Nej
4	Volymindikering möjligt									Ja	Nej
5	Programnummervisning möjligt									Ja	Nej
6	Frontpanel låsning									Ja	Nej
7	Automatisk avstängning									Ja	Nej

Serviceinställningar via I²C-bus

Fjärrkontrollknappar i serviceläge

När tv:n är i serviceläge kan du välja normalt tv-läge med TV-knappen och återvända till serviceläge med i-knappen. Siffer- och markörknappar används vid serviceinställningar och OK-knappen till att spara inställningen.

Inställningar för olika bildformat

Gör alla inställningar med PAL-signal om inte annat nämns. Gör först alla inställningar med normalt 4:3-bildformat. Gör därefter alla nödvändiga inställningar med andra bildformat/signaler. Nödvändiga inställningar visas i efterföljande tabell.

Obs! Kontrollera TV:ns konfiguration före du gör någon inställning och gör endast nödvändiga inställningar.

Serviceinställningar

1. Välj koden, som gäller för önskad justering (t.ex. 06 = bildbredd, se följande tabell), med sifferknapparna. Justeringarna kan också väljas med markörknapparna (upp-/nedåt).

SERVICE

06 WIDTH

49 33

2. Justera med markörknapparna (vänster/höger).

SERVICE

06 WIDTH

49 36

3. Spara inställningen med OK-knappen.

Obs!

- Spara justering omedelbart för att undvika ofullständig justering.
- Bör justering göras skilt för olika bildformat/signaler, välj normalt tv-läge med TV-knappen, ändra bildformat/signal och återvänd till serviceläge med i-knappen.

Bildgeometri-inställningar

Justering	Kod	OSD namn	normal (4:3)	bred film	VGA 60 Hz	VGA 70 Hz	RGB	Obs!
Vertikal amplitud	00	V-AMPL.	X	X	X			
Vertikal centrering	01	V-SHIFT	X		X			
Vertikal start	02	V-START	X		X	X		
Vertikal S-korrigerig	03	S-CORR.	X	X	X			
Vertikal amplitud (grov)	04	SLOPE-H	X		X	X		Gör även justering med NTSC-signal.
Vertikal amplitud (fin)	05	SLOPE-L	X					Gör även justering med NTSC-signal.
Bildbredd	06	WIDTH	X		X	X		
Horisontal fas avlänkning	07	H-SHIFT	X					Inte i alla mottagarna.
Horisontal fas video	08	PHASE	X		X	X	X	
Öst-Väst-parabol	09	PARABOLA	X	X	X			
Öst-Väst-hörnkorrigerig	10	CORNER	X	X	X			
Öst-Väst-trapetskorrigering	11	TRAPEZIUM	X		X			
EHT-kompensering	12	EHT	X		X			Ställ ljus och kontrast till 90% och kompensera bildstorlek variationer.

VGA 60 Hz = Windows läge

VGA 70 Hz = DOS läge

Övriga inställningar

Justering	Kod	OSD namn	Obs!
Röd referens	18	R REF.	Denna procedur är nödvändig när t.ex. bildrör eller CRT-modul är utbytt. Anslut en testbild och ställ in R-, G- och B-referens. Ställ därefter in R-, G- och B-förstärkning.
Grön referens	19	G REF.	
Blå referens	20	B REF.	
Röd förstärkning	15	R GAIN	
Grön förstärkning	16	G GAIN	
Blå förstärkning	17	B GAIN	
Vitbegränsning	21	PWL	Normalt krävs ingen justering.
Luma fördröjning	14	LUMA DELAY	Separat justering för Video, PAL BG, PAL DK/I och Secam L.

Serviceinställningar

O Nätdelen

Drivspänning (U1) och skyddskrets

1. Ställ ljus och kontrast till normal nivå. Anslut en universal voltmätare till katoden på Do11.
2. Justera DC-spänningen U1 med Ro45. Spänningen är beroende på bildrörstyp, kontrollera spänningen från avsnitt "Komponentskillnader".
3. Kontrollera överströmsskyddets funktion efter serviceingrepp på nätdelens primärsida. Aktivera service-lägen och ställ mottagaren i beredskapsläge. Kortslut diodens Do13 katod till jord och håll kortslutningen på plats. När överströmsskyddet fungerar, försöker nätdelen att starta 2-3 ggr före den slutar definitivt. Ta bort kortslutningen och slå på apparaten med huvudströmbrytaren.

SR Tuner/MF-modulen (Frontend)

Kanalväljar AGC

Kanalväljar AGC:n justeras med en potentiometer via ett hål i kylplattan (se figuren nedtill).

Anslut en 1 mV (60 dB μ V) testsignal och justera bilden brusfri.

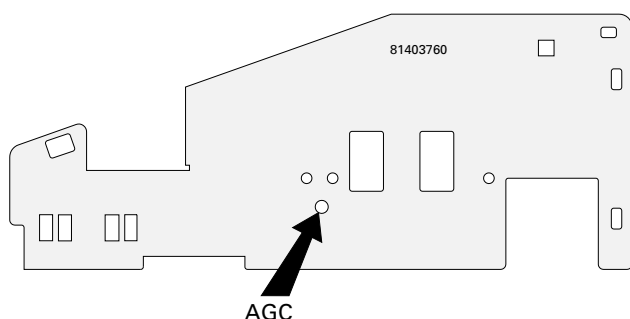

K Horisontalavläkningsblocket

Horisontal linearitet

Justera med Lk2.

Fokus

Ställ ljus till normal nivå och kontrast till hög nivå. Använd en testbild med ruttmönster och justera bilden för maximum skärpa.

Skärmgallerspänning Ug2

1. Ställ kontrast i minimum, ljus och färgmättnad till normal nivå.
2. Efter vertikalsläckning finns en svartnivå mätpuls. Mät med ett oscilloskop på ICh1 stift 9, ICh2 stift 9 och ICh3 stift 9. Kontrollera vilket steg som har den högsta svartnivån (högsta spänningen på svartnivå mätpulsen).
3. Justera med Ug2 spänningen till +140 V (Se figuren).

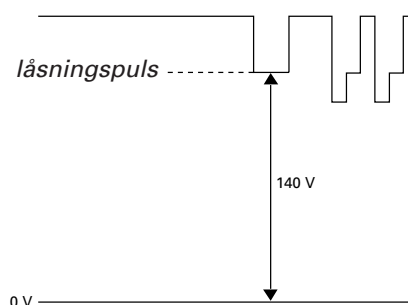

Obs! Justera spänningen med låsningspulsen (Clamp puls).

Mode d'emploi

Modification de la langue du menu

1. Appuyez sur la touche jaune pour sélectionner le menu Image.
2. Appuyez sur la touche rouge pour sélectionner le menu Affichage écran.
3. Sélectionnez la langue du menu à l'aide des touches curseurs.
4. Appuyez sur la touche OK pour enregistrer les modifications.
5. Appuyez sur la touche TV pour quitter le menu.



Recherche manuelle

1. Sélectionnez le numéro du programme que vous voulez régler.
2. Appuyez sur la touche MENU.
3. Sélectionnez l'option "Syntonisation" et appuyez sur la touche OK.
4. Sélectionnez l'option "Recherche manuelle" et appuyez sur la touche OK.
5. Lancez la recherche de canal à l'aide de la touche rouge.
6. Pour mémoriser vos sélections, appuyez sur la touche OK.
7. Appuyez sur la touche TV pour quitter le menu.



Système de programmation automatique (APSi)

1. Appuyez sur la touche MENU.
2. Sélectionnez l'option "Syntonisation" et appuyez sur la touche OK.
3. Sélectionnez l'option "Syntonisation automatique" et appuyez sur la touche OK.
4. Pour régler les chaînes, appuyez sur la touche rouge.
5. Appuyez sur la touche TV pour quitter le menu.

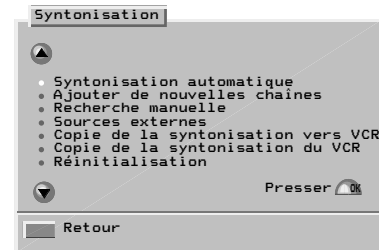

Sélection de l'entrée VGA

1. Appuyez sur la touche MENU.
2. Sélectionnez l'option "Syntonisation" et appuyez sur la touche OK.
3. Sélectionnez l'option "Sources externes" et appuyez sur la touche OK.
4. Sélectionnez l'option "VGA computer" et appuyez sur la touche TV. (Si l'option "VGA computer" ne se trouve pas dans la liste, sélectionnez l'option "Ajouter une source" en appuyant sur la touche rouge.)

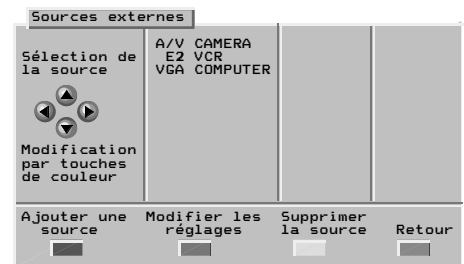

Initialisation de la NVRAM

Initialisation de la NVRAM (ICf2)

Si la RAM non volatile (NVRAM) est remplacée, elle doit être initialisée et configurée.

1. Mettez le téléviseur en mode mise en veille. Appuyez sur la touche ◀- (abaissement du volume) de l'unité de commande centralisée et commencez simultanément à saisir le mot de passe : MENU, TV et i avec la télécommande. Relâchez la touche ◀- après avoir appuyé sur la touche MENU. Le voyant d'enregistrement s'allume pour indiquer que le mode maintenance est activé.
2. Appuyez sur la touche rouge pour pré-configurer le téléviseur. Le voyant vert clignote ensuite une fois.
- 3a. Pendant ce temps, le contrôleur vérifie la NVRAM et l'initialise automatiquement si elle est "vide". L'initialisation prend environ 15 secondes. Quand elle est achevée, le voyant vert s'allume. Passez à l'étape 4.
- 3b. Le voyant vert n'est pas allumé en continu si l'initialisation automatique ne s'est pas produite. Dans certains cas, le voyant peut également s'allumer immédiatement après la configuration sans aucune initialisation, selon le contenu de la NVRAM. Dans ce cas, il suffit d'enregistrer la nouvelle configuration en appuyant sur OK. Passez ensuite à l'étape 4.
- 3c. Si l'initialisation automatique ne s'est pas produite, vous pouvez la lancer manuellement en entrant le code clé : bleu (attendez environ 2 secondes), 2, 5, 4 (attendez environ 2 secondes) et OK. L'initialisation prend environ 15 secondes.
4. Eteignez le récepteur en appuyant sur l'interrupteur principal.
5. Lancez le récepteur en mode de réception TV en appuyant sur l'interrupteur principal. Réglez une ou plusieurs chaînes de télévision.
6. Eteignez le récepteur avec la télécommande.
7. Entrez en mode maintenance et effectuez les réglages (reportez-vous à la section "Réglages de service au moyen du bus I²C").
8. Eteignez le récepteur en appuyant sur l'interrupteur principal.

Réglages de service

Sélection du mode service

1. Mettez le téléviseur en mode mise en veille.
2. Appuyez sur la touche (abaissement du volume) de l'unité de commande centralisée et commencez simultanément à saisir le mot de passe : MENU, TV et i avec la télécommande. Relâchez la touche après avoir appuyé sur la touche MENU. Le voyant d'enregistrement s'allume pour indiquer que le mode service est activé.
3. Allumez le téléviseur en appuyant deux fois sur la touche TV et sélectionnez le mode service en appuyant sur la touche i.



En mode maintenance, un menu de réglage apparaît à l'écran. Le numéro et le nom du réglage, les valeurs d'initialisation (à gauche) et de réglage (à droite) sont affichées dans le menu.

4. Quittez le mode maintenance en éteignant le téléviseur avec l'interrupteur principal.

Configuration et diagnostic de panne

Vous devez configurer le téléviseur après tout ajout ou suppression d'options. En appuyant sur la touche rouge en mode service, le processeur contrôle la configuration du téléviseur et affiche les paramètres à l'écran. Vous pouvez enregistrer la configuration en appuyant sur la touche OK.

Cette fonction peut également être utilisée pour le diagnostic de panne. Si un bit d'option n'a pas la valeur '1' comme il devrait l'être, cela signifie que le CI (ou la fonction) est soit absent, soit défaillant.

Modification des octets d'options

1. Sélectionnez le mode configuration en appuyant sur la touche rouge en mode service.

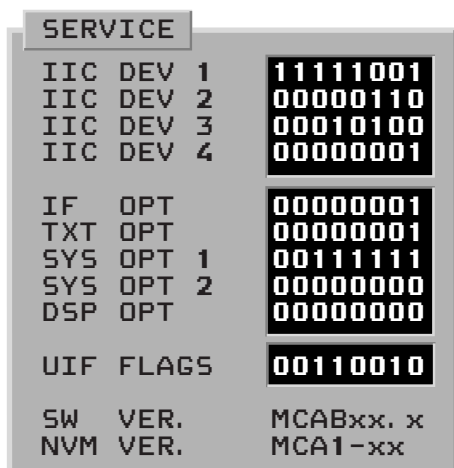

SW VER. = version logicielle µP.

NVM VER. = version logicielle NVM.

2. Sélectionnez IIC Device byte 1 - 4, Option byte 1 - 5 ou uif flags byte avec la touche curseur (vers le haut/vers le bas). L'octet sélectionné apparaît en surbrillance.
3. Définissez les bits à l'aide des touches numériques (0 ... 7).
4. Mémorisez les paramètres en appuyant sur la touche OK.
5. Retournez en mode service normal en appuyant sur la touche rouge.

Descriptions des octets d'option

Bit	Description	7	6	5	4	3	2	1	0	'1'	'0'
IIC DEV 1 11111001											
0	Tuner TV									oui	non
1	Sortie FI, HEF4094									oui	non
3	Processeur synchro décodeur, TDA9143									oui	non
4	Contrôleur déflexion, TDA9151									oui	non
5	Processeur RVB, TDA4780									oui	non
6	Processeur IQTV									oui	non
7	DPLL									oui	non
IIC DEV 2 00000110											
0	VGA									oui	non
1	Interrupteur vidéo principal TDA6417									oui	non
2	Processeur Son, MSP3410									oui	non
3	Tube 16:9									oui	non
4	Filtre-peigne									oui	non
5	Processeur PIP, SDA9188 + TDA9141									oui	non
6	Tuner PIP (image dans l'image)									oui	non
7	SCART 3 installé									oui	non
IIC DEV 3 00010100											
0	Son virtuel (3D Sound)									oui	non
1	Processeur Dolby									oui	non
2	Processeur SDA30C264									oui	non
3	Subwoofer									oui	non
4	Megatext, SDA5273/75									oui	non
5	Mémoire texte externe									oui	non
6	Megatext Level 2.5									oui	non
7	Mémoire un champ (Module DB711)									oui	non
IIC DEV 4 00000001											
0	Nicam activé									oui	non
1	Ligne de commande (Xata) au module AR7xx									oui	non
IF OPT 00000001											
0	Système B/G									oui	non
1	Système I									oui	non
2	Système D/K									oui	non
3	Système L/L'									oui	non
TXT OPT 00000001											
0	TOP text activé									oui	non
1	Flof text activé									oui	non
2	P26 activé									oui	non
3	TXT accrochage mode									oui	non
4	TXT souspage défilement									oui	non
5	Fonction EPG (nexTVView) activée									oui	non
6	Fonction d'enregistrement EPG activée									oui	non
SYS OPT 1 00111111											
0	E0 (connecteur A/V) installé									oui	non
1	Vidéo S (E0)									oui	non
2	RVB uniquement activé dans E1									oui	non
3	Fonction ACI activée									oui	non
4	Alimentation micro installée									oui	non
5	Blocage de porteuse activé									oui	non
SYS OPT 2 00000000											
0	Rotation activé									oui	non
1	Démarrage automatique (TV hôtel)									oui	non
7	Fonctions TV hôtel activées (manuel)									oui	non
UIF FLAGS 00110010											
0-2	Bit de logo										
	000 = pas de logo, aller directement à la fonction APSi										
	001 = pas de logo, aller au menu Langue										
	010 = Logo Akai										
	011 = Logo Nokia										
	100 = Logo Finlux										
	101 = Logo Salora										
	110 = Logo Luxor										
3	Téléviseur non utilisé auparavant									oui	non
4	Barre de volume activée									oui	non
5	Numéro de programme activé à l'écran									oui	non
6	Verrouillage du panneau avant									oui	non
7	Compteur d'arrêt actif									oui	non

Réglages de service au moyen du bus I²C

Touches de la télécommande en mode service

Quand le récepteur est en mode service, vous pouvez sélectionner le mode de réception TV normal en appuyant sur la touche TV et retourner au mode service en appuyant sur la touche i. Les touches numériques et les touches curseurs sont utilisés pour le réglage de service. La touche OK permet de mémoriser les paramètres.

Réglages pour un format d'image différent

Sauf indication contraire, effectuez tous les réglages avec le signal PAL. Commencez par effectuer les réglages avec le format d'image normal 4:3. Ensuite, procédez à tous les réglages nécessaires avec les autres signaux et formats d'image. Les réglages requis sont décrits dans le tableau ci-dessous.

Remarque ! Contrôlez la configuration du téléviseur avant de procéder aux réglages et n'effectuez que ceux qui sont indispensables.

Réalisation des réglages de service

1. Définissez un code à deux chiffres pour déterminer le réglage (par ex. 06 = largeur E-O, voir les tableaux suivants) à l'aide des touches numériques. Vous pouvez également sélectionner le réglage avec les touches curseurs (vers le haut/vers le bas).

SERVICE

06 WIDTH

49 33

2. Procédez au réglage avec les touches curseurs (gauche/droite).

SERVICE

06 WIDTH

49 36

3. Mémorisez la nouvelle valeur en appuyant sur la touche OK.

Remarque !

- Pour éviter les réglages incomplets, enregistrez chaque réglage en mémoire immédiatement après l'avoir effectué.
- Si le réglage doit être réalisé séparément pour chaque signal et format d'image différent, sélectionnez le mode utilisateur normal en appuyant sur la touche de réception TV et sélectionnez le signal et format d'image de votre choix. Revenez en mode service en appuyant sur la touche i.

Reglages géométrique d'image

Réglage	Code	Nom OSD	classique (4:3)	cinemascope	VGA 60 Hz	VGA 70 Hz	RVB	Remarque !
Amplitude verticale	00	V-AMPL.	X	X	X			
Décentrage vertical	01	V-SHIFT	X		X			
Balayage vertical	02	V-START	X		X	X		
Correction S Verticale	03	S-CORR.	X	X	X			
Dent de scie vert. (grossière)	04	SLOPE-H	X		X	X		Effectuez aussi le réglage avec le signal NTSC.
Dent de scie vert. (précise)	05	SLOPE-L	X					Effectuez aussi le réglage avec le signal NTSC.
Largeur E-O	06	WIDTH	X		X	X		
Phase horizontale déflexion	07	H-SHIFT	X					Ne concerne pas tous les téléviseurs.
Phase horizontale vidéo	08	PHASE	X		X	X	X	
Parabole E-O	09	PARABOLA	X	X	X			
Coin E-O	10	CORNER	X	X	X			
Déformation trapézoïdale E-O	11	TRAPEZIUM	X		X			
Compensation EHT	12	EHT	X		X			Portez la lumière et le contraste à 90% et compensez le changement dans la taille de l'image.

VGA 60 Hz = mode Windows
VGA 70 Hz = mode DOS

Autres réglages

Réglage	Code	Nom OSD	Remarque !
Référence rouge	18	R REF.	La procédure est nécessaire lorsque, par exemple, le tube image ou le module CRT a été remplacé. Appliquez une mire et réglez les références R, V et B. Réglez ensuite les amplifications R, V et B.
Référence vert	19	G REF.	
Référence bleu	20	B REF.	
Amplification rouge	15	R GAIN	
Amplification vert	16	G GAIN	
Amplification bleu	17	B GAIN	
Seuil des crêtes de blanc	21	PWL	Normalement pas besoin de régler.
Délai de luminance	14	LUMA DELAY	Réglage distinct pour Vidéo, PAL BG, PAL DK/I et Secam L.

Réglages de service

O Bloc d'alimentation

Tension d'alimentation et circuit de protection

- Réglez la luminosité et le contraste à un niveau normal. Branchez un voltmètre universel à la cathode Do11.
- Réglez la tension U1 avec Ro45. La tension dépend du type de tube image du téléviseur ; reportez-vous à la section "Composants variables".
- Contrôlez le dispositif de protection contre les surcharges après toute opération de maintenance dans le circuit principal de l'alimentation. Activez le mode maintenance, puis mettez le téléviseur en mode mise en veille. Court-circuitez la cathode Do13 à la masse et maintenez le court-circuit connecté. Quand le dispositif de protection contre les surcharges fonctionne correctement, l'alimentation est stoppée définitivement après trois tentatives. Supprimez le court-circuit et allumez le récepteur en appuyant sur le bouton d'alimentation.

SR Tuner/Module IF (Frontend)

Tuner CAG

Le tuner CAG se règle avec un potentiomètre par un trou dans le dissipateur thermique (voir illustration ci-dessous). Appliquez un signal de mesure de 1 mV (60 dB μ V) et réglez la netteté de l'image pour qu'elle ne contienne aucun parasite.

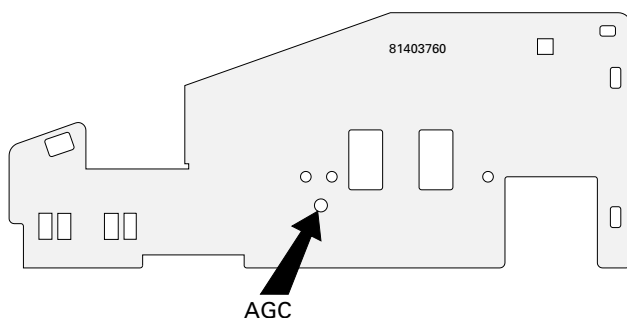

K Bloc de déflexion horizontale

Linéarité horizontale

Effectuez le réglage avec Lk2.

Mise au point

Définissez la luminosité et le contraste à un niveau normal. Utilisez la mire de quadrillage et réglez l'image pour une résolution optimale.

(Tension de la grille-écran) Tension Ug2

- Définissez la luminosité et la saturation couleur à un niveau normal ainsi que le contraste à un niveau minimum.
- A la fin de de la suppression de trame, apparaît une impulsion de mesure du niveau de noir à la broche 9 de ICh1, ICh2 et ICh3. Utilisez un oscilloscope pour trouver l'étage de sortie avec la coupure la plus élevée (c'est-à-dire la tension la plus élevée pendant l'impulsion de mesure du niveau de noir).
- Réglez la tension des Ug2 à +140 V (voir l'illustration).

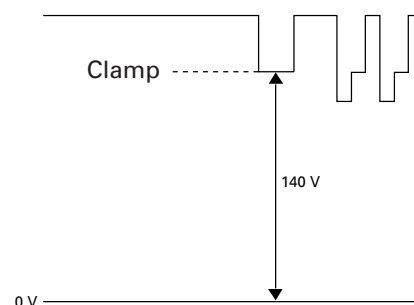

Remarque ! Réglez la tension avec le clamp.

Istruzioni per l'uso

Modifica della lingua dei menu

1. Premere il tasto giallo per selezionare il menu Immagine.
2. Premere il tasto rosso per selezionare il menu Indicazioni su schermo.
3. Cambiare la lingua del menu con i tasti cursore.
4. Premere il tasto OK per memorizzare le modifiche.
5. Premere il tasto TV per uscire.



Sintonia manuale

1. Selezionare il numero programma che si desidera sintonizzare.
2. Premere il tasto MENU.
3. Selezionare "Sintonia" e premere il tasto OK.
4. Selezionare "Sintonia manuale" e premere il tasto OK.
5. Premere il tasto rosso (Ricerca del canale).
6. Premere il tasto OK per memorizzare.
7. Premere il tasto TV per uscire.



APSi (Automatic Programming System)

1. Premere il tasto MENU.
2. Selezionare "Sintonia" e premere il tasto OK.
3. Selezionare "Nuova sintonia automatica" e premere il tasto OK.
4. Per risintonizzare i canali, premere il tasto rosso.
5. Premere il tasto TV per uscire.

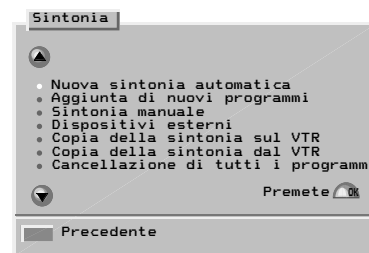

Selezione dell'ingresso VGA

1. Premere il tasto MENU.
2. Selezionare "Sintonia" e premere il tasto OK.
3. Selezionare "Dispositivi esterni" e premere il tasto OK.
4. Selezionare "VGA computer" e premere il tasto TV.
(Se il "VGA computer" non è nell'elenco, selezionare "Nuovo dispositivo" premendo il tasto rosso.)



Inizializzazione di NVRAM

Inizializzazione di NVRAM (ICf2)

Nel caso in cui si sostituisca il modulo NVRAM, questo deve essere inizializzato e configurato.

1. Impostare l'apparecchio TV in modo standby. Premere il tasto (diminuzione volume) sul telecomando dell'apparecchio TV e contemporaneamente immettere la parola d'ordine: MENU, TV e i tramite telecomando. Rilasciare il tasto dopo avere premuto il tasto MENU. Il led della registrazione si accende per indicare che è stato abilitato il modo assistenza tecnica.
2. Premere il tasto rosso per preficonfigurare l'apparecchio. Ad indicare ciò, il led verde lampeggia una volta.
- 3a. Allo stesso tempo il controllore verifica il modulo NVRAM e lo inizializza automaticamente se è "vuoto". L'inizializzazione durerà circa 15 secondi. Una volta completata l'inizializzazione, il led verde si accende. Continuare al punto 4.
- 3b. L'inizializzazione automatica non è stata eseguita se il led verde non si accende a luce fissa. In alcuni casi, il led potrebbe anche accendersi subito dopo la configurazione senza alcuna inizializzazione, a seconda del contenuto del modulo NVRAM. In questo caso, potrebbe essere sufficiente memorizzare la nuova configurazione premendo "OK". Continuare al punto 4.
- 3c. Se l'inizializzazione automatica non è stata eseguita, è possibile avviarla manualmente immettendo il codice: BLU (attendere circa 2 secondi), 2, 5, 4 (attendere circa 2 secondi) e OK. L'inizializzazione durerà circa 15 secondi.
4. Spegner il ricevitore premendo l'interruttore generale.
5. Avviare il ricevitore in modo TV premendo l'interruttore generale. Sintonizzare uno o più canali TV.
6. Spegner il ricevitore tramite telecomando.
7. Avviare il modo assistenza tecnica ed eseguire le regolazioni di servizio (vedere la sezione "REGOLAZIONI DI SERVIZIO TRAMITE BUS I²C").
8. Spegner il ricevitore premendo l'interruttore generale.

Regolazioni di servizio tramite bus I²C

Tasti del telecomando in modo assistenza tecnica

Quando il ricevitore si trova in modo assistenza tecnica, è possibile selezionare il normale modo TV premendo il tasto TV e tornare al modo assistenza tecnica premendo il tasto i. Per le regolazioni di servizio, vengono usati i tasti numerici ed i tasti cursore. Il tasto OK serve a memorizzare le impostazioni.

Regolazione per diverso formato immagine

Effettuare tutte le regolazioni con segnale PAL se non diversamente indicato. Prima di tutto, effettuare tutte le regolazioni con formato immagine 4:3 normale. Poi, effettuare le necessarie regolazioni con altri segnali/formati immagine. Le regolazioni necessarie sono indicate nella tabella di seguito riportata.

Nota! Controllare la configurazione dell'apparecchio TV prima di effettuare le regolazioni e procedere solo con quelle effettivamente necessarie.

Come effettuare una regolazione di servizio

1. Immettere un codice numerico a due cifre che definisca la regolazione (ad esempio 06 = larghezza EW, vedere le tabelle) tramite i tasti numerici. E' anche possibile selezionare la regolazione usando i tasti cursore (su/giù).

SERVICE

06 WIDTH

49 33

2. Effettuare la regolazione con i tasti cursore (sinistro/destro).

SERVICE

06 WIDTH

49 36

3. Memorizzare il nuovo valore premendo il tasto OK.

Nota:

- Per evitare regolazioni incomplete, memorizzare ciascuna regolazione subito dopo averla effettuata.
- Se la regolazione deve essere effettuata separatamente per diverso segnale/formato immagine, selezionare il normale modo utente premendo il tasto TV e selezionare il segnale/formato immagine desiderato. Tornare al modo assistenza tecnica premendo il tasto i.

Regolazioni geometria dell'immagine

Regolazione	Codice	Display	norm. (4:3)	film wide	VGA 60 Hz	VGA 70 Hz	RVB	Nota!
Ampiezza verticale	00	V-AMPL.	X	X	X			
Spostamento centatura vert.	01	V-SHIFT	X		X			
Inizio scansione verticale	02	V-START	X		X	X		
Correzione-S verticale	03	S-CORR.	X	X	X			
Pendenza vert. (approssimata)	04	SLOPE-H	X		X	X		Regolare anche con il segnale NTSC.
Pendenza verticale (fine)	05	SLOPE-L	X					Regolare anche con il segnale NTSC.
Larghezza EW	06	WIDTH	X		X	X		
Fase orizzontale, deviazione	07	H-SHIFT	X					Non in tutti gli apparecchi.
Fase orizzontale, video	08	PHASE	X		X	X	X	
Parabola EW	09	PARABOLA	X	X	X			
Angolo EW	10	CORNER	X	X	X			
Trapezoidale EW	11	TRAPEZIUM	X		X			
Compensazione EHT	12	EHT	X		X			Impostare luminosità e contrasto a 90% e modificare di conseguenza la dimensione dell'immagine.

VGA 60 Hz = modo Windows

VGA 70 Hz = modo DOS

Altre regolazioni

Regolazione	Codice	Display	Nota!
Riferimento rosso	18	R REF.	Questa procedura è necessaria quando si sostituisce il cinescopio, il modulo CRT etc. Collegare un segnale test e regolare i riferimenti di R, V e B. Regolare il guadagno di R, V e B.
Riferimento verde	19	G REF.	
Riferimento blu	20	B REF.	
Guadagno rosso	15	R GAIN	
Guadagno verde	16	G GAIN	
Guadagno blu	17	B GAIN	
Limite picco bianco	21	PWL	Regolazione generalmente non necessaria.
Ritardo di luminanza	14	LUMA DELAY	Regolazione separata per Video, PAL BG, PAL DK/I e Secam L.

Regolazioni di servizio

O Blocco alimentatore

Tensione di alimentazione e circuito di protezione

1. Impostare luminosità e contrasto sul livello normale.
Collegare un voltmetro universale al catodo Do11.
2. Regolare la tensione U1 con Ro45. La tensione dipende dal tipo di tubo catodico, fare riferimento alla sezione "Componenti che differiscono".
3. Controllare la protezione da sovratensione dopo avere eseguito qualsiasi tipo di intervento tecnico sul circuito primario dell'alimentatore. Attivare il modo assistenza tecnica e poi impostare l'apparecchio in modo standby. Cortocircuitare a terra il catodo Do13 e mantenere il corto circuito. Quando la protezione da sovratensione funziona correttamente, l'alimentatore proverà ad avviarsi 2-3 volte prima di fermarsi definitivamente. Rimuovere il cortocircuito ed accendere il ricevitore premendo il tasto di alimentazione.

SR Sintonizzatore/Modulo FI (Frontend)

Sintonizzatore AGC

Il sintonizzatore AGC è regolato tramite un potenziometro attraverso un foro nello scambiatore termico (vedere la figura che segue). Applicare un segnale di prova da 1 mV (60 dB μ V) e regolare l'immagine in modo che non risulti disturbata.

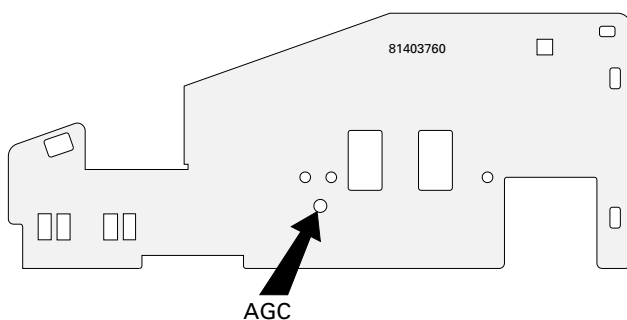

K Blocco di deflessione orizzontale

Linearità orizzontale

Regolare con Lk2.

Messa a fuoco

Impostare la luminosità ed il contrasto su un livello normale. Usare il monoscopio e regolare l'immagine sulla risoluzione ottimale.

(Tensione griglia schermo) tensione Ug2

1. Impostare la luminosità e la saturazione dei colori su un livello normale ed il contrasto al minimo.
2. Alla fine dello spegnimento verticale, vi è un impulso di misurazione della corrente sul nero (impulso di aggancio) al piedino 9 di ICh1, ICh2 e ICh3. Usare un oscilloscopio e la fase di uscita con il cut-off più alto (ad esempio, la tensione più alta durante l'impulso di misurazione della corrente sul nero).
3. Regolare la tensione dell'impulso di aggancio su +140 V con Ug2 (vedere la figura).

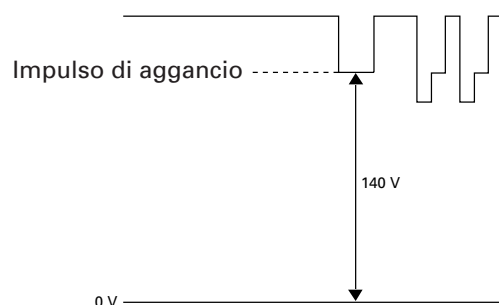

Nota! Regolare la tensione con l'impulso di aggancio.

AJ602 Crossover network

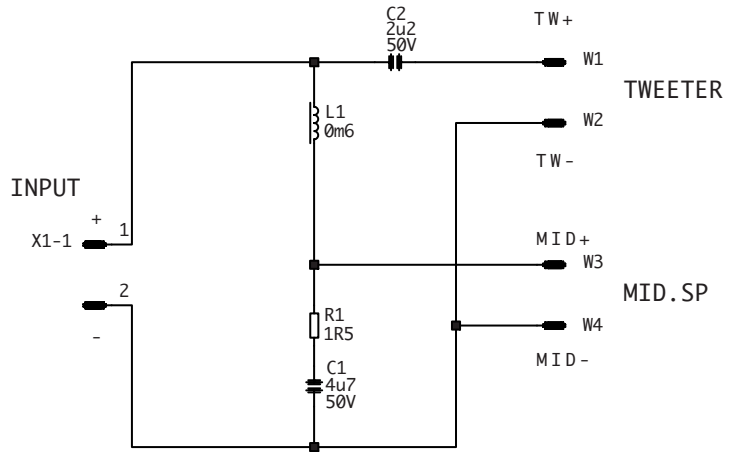
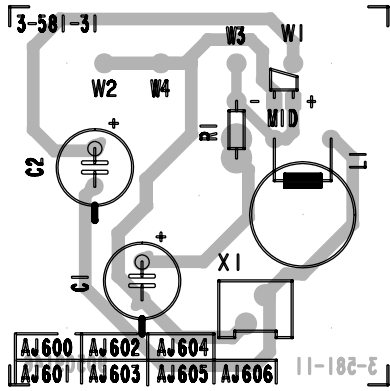

CF700 Comb filter module

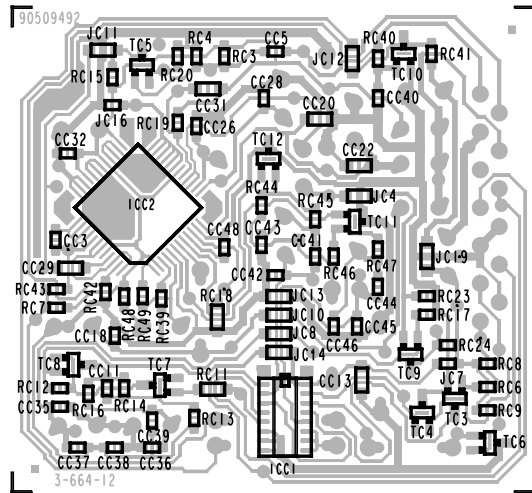
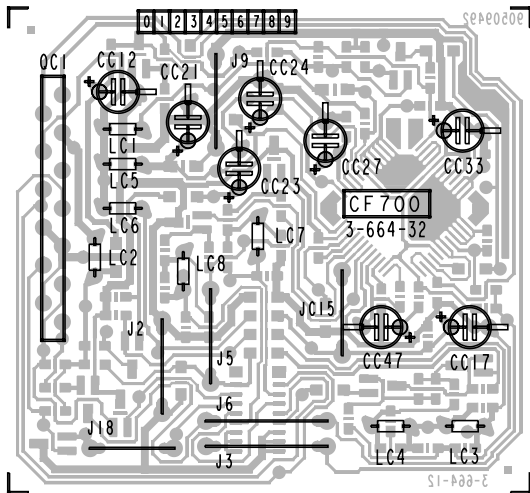

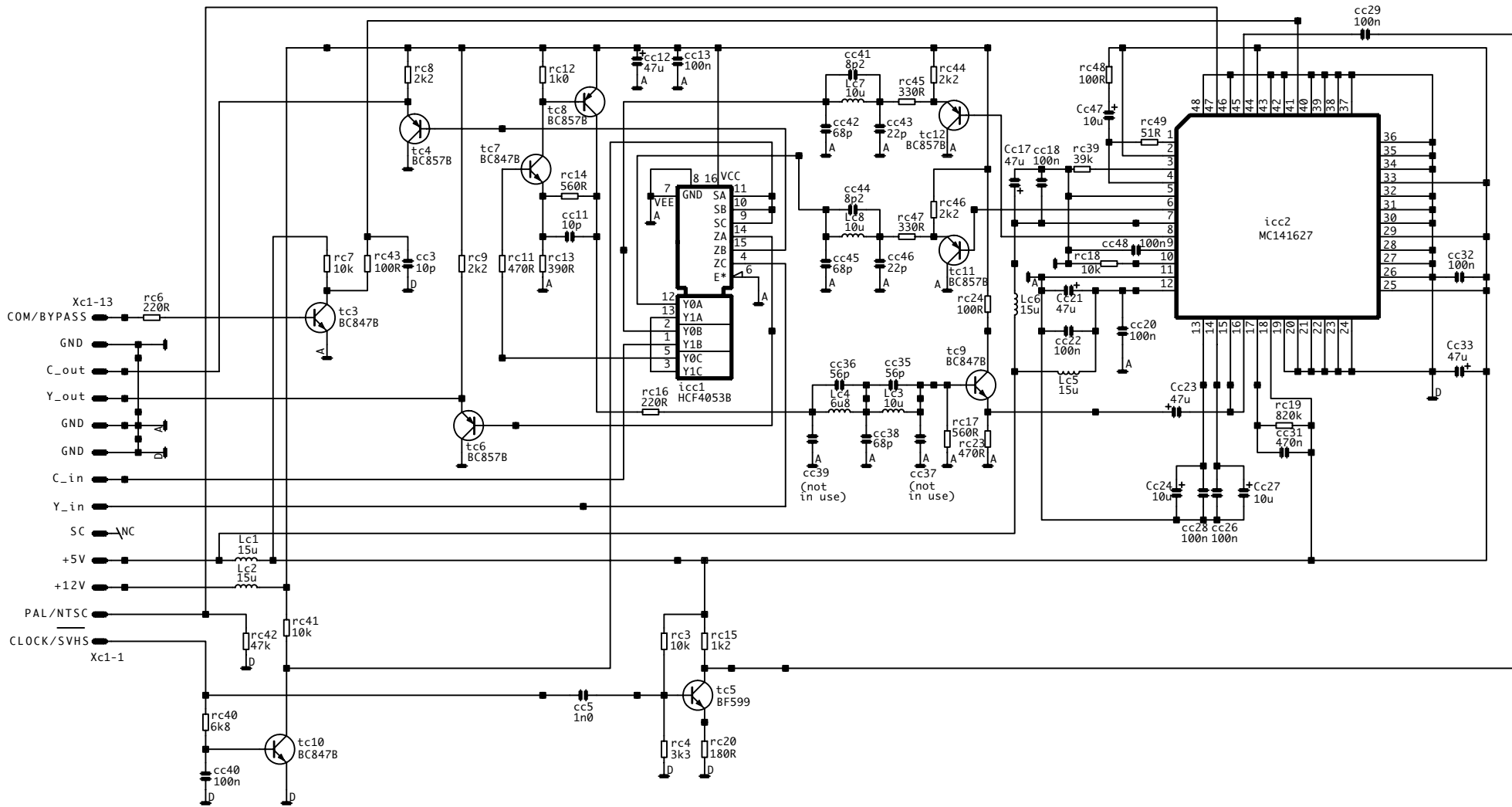

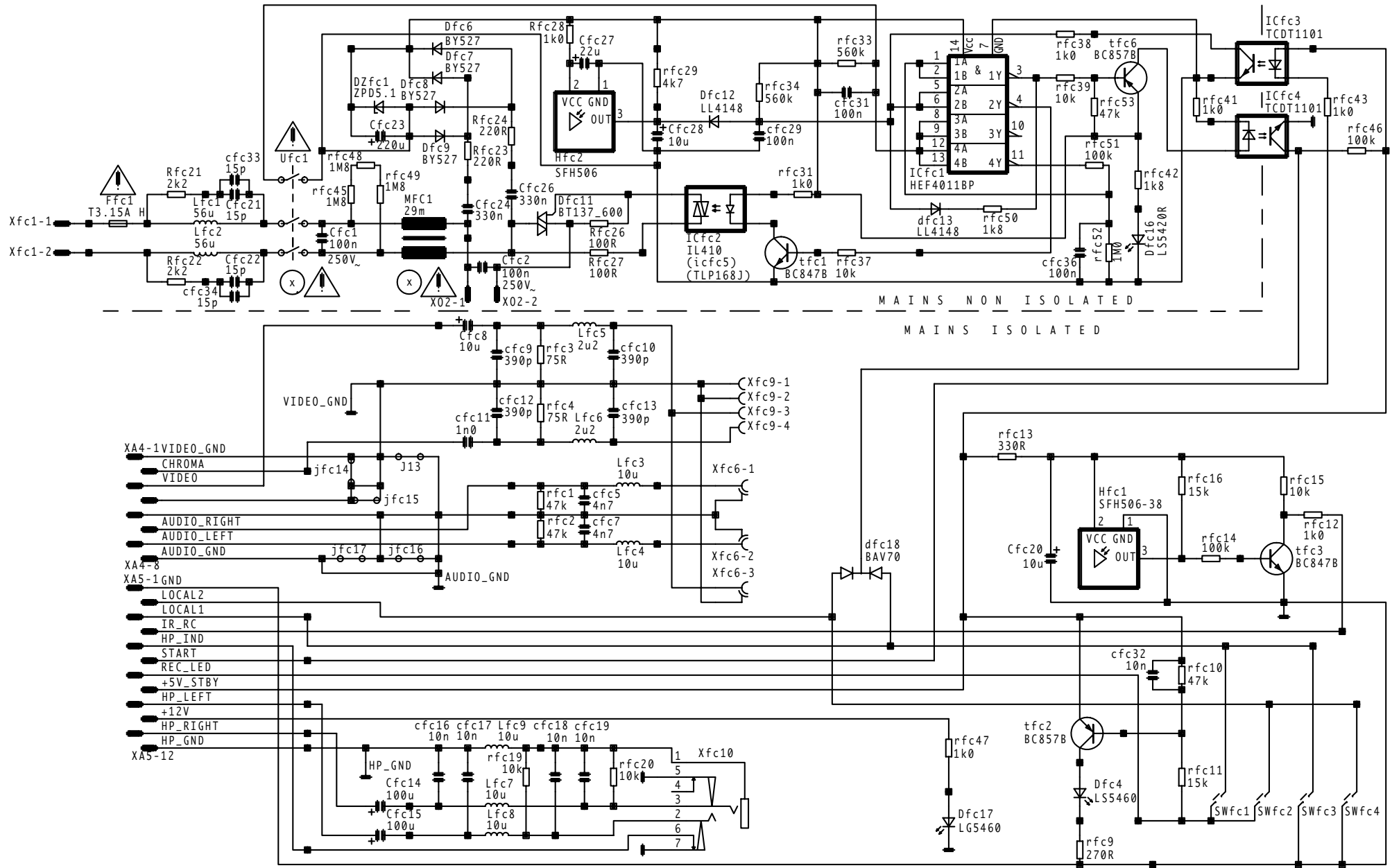

FO712 Horizontal shift module

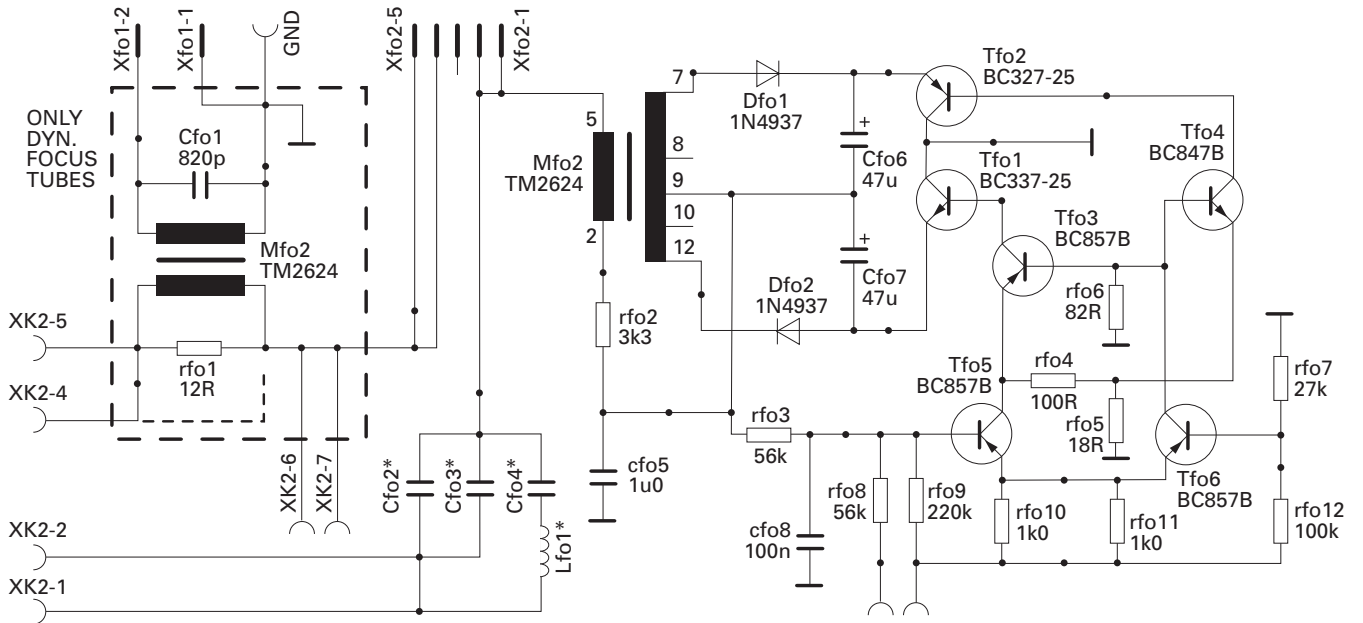
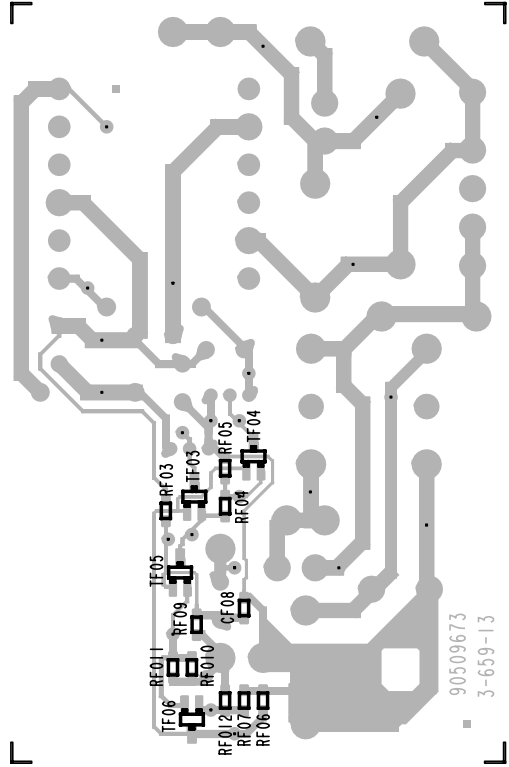
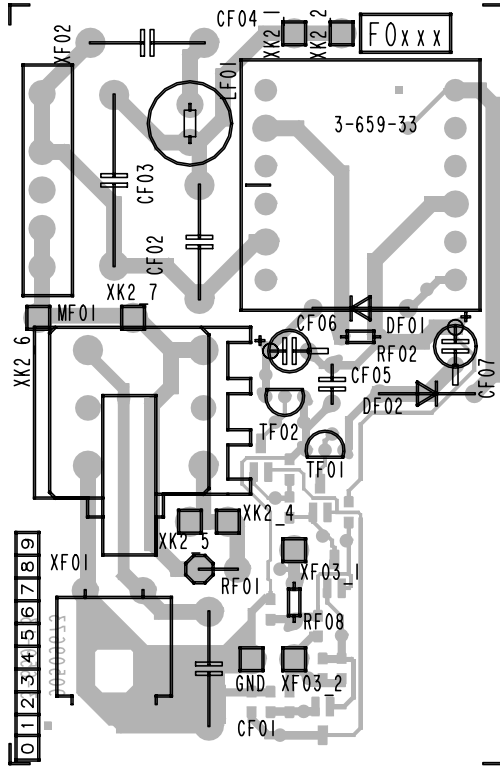

SW600 140V Switch module

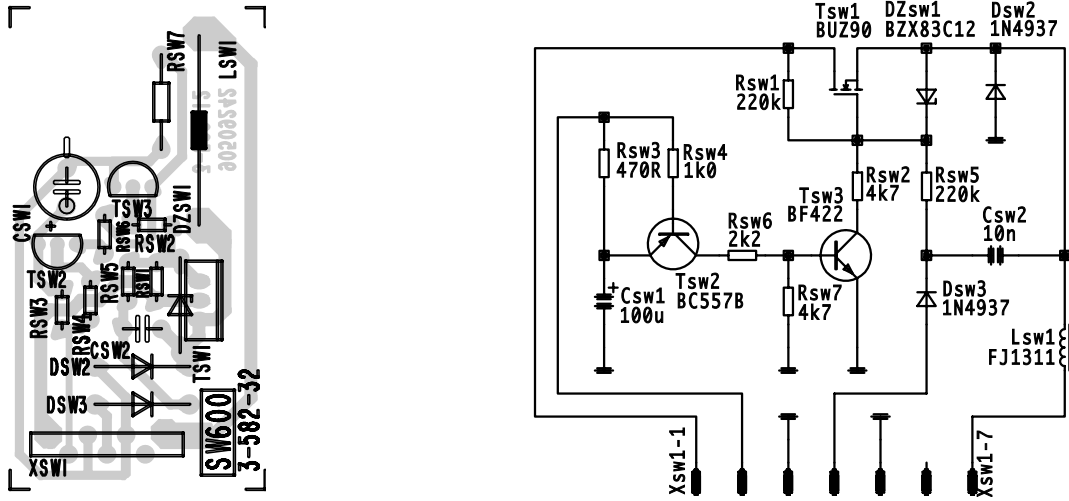

HH703/705 CRT-module

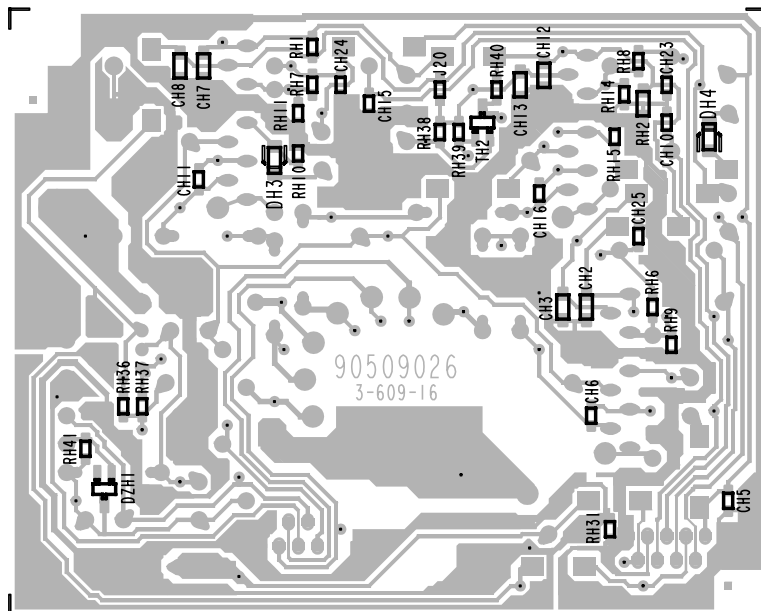
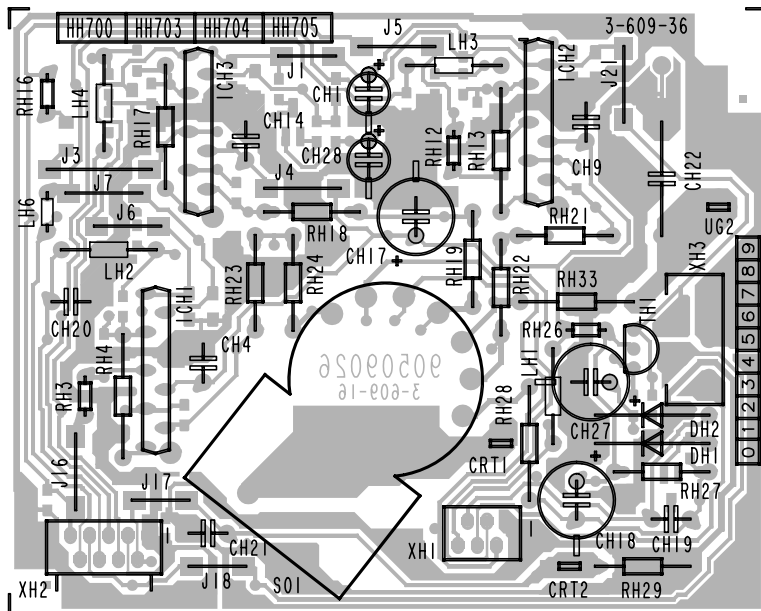

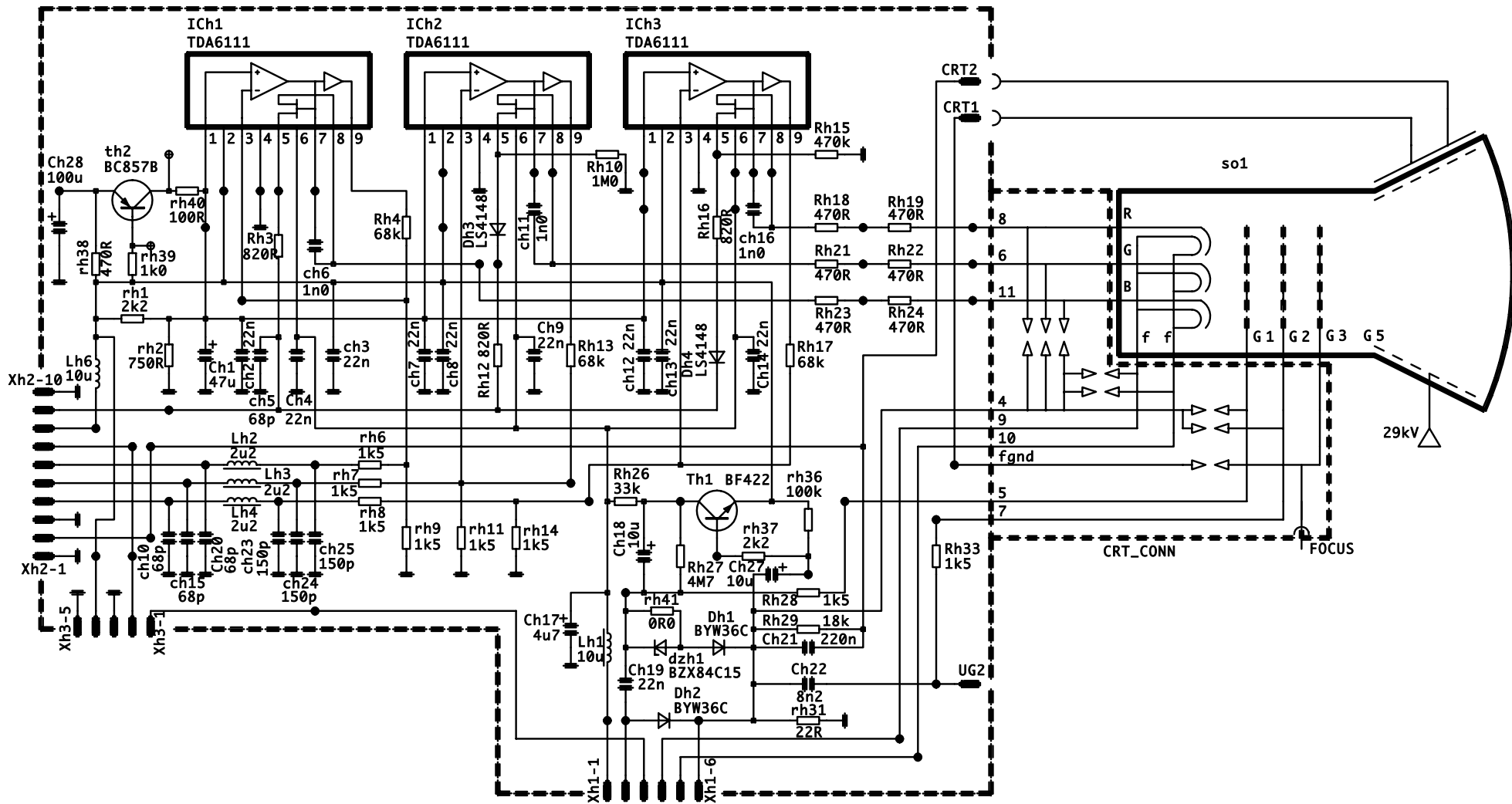

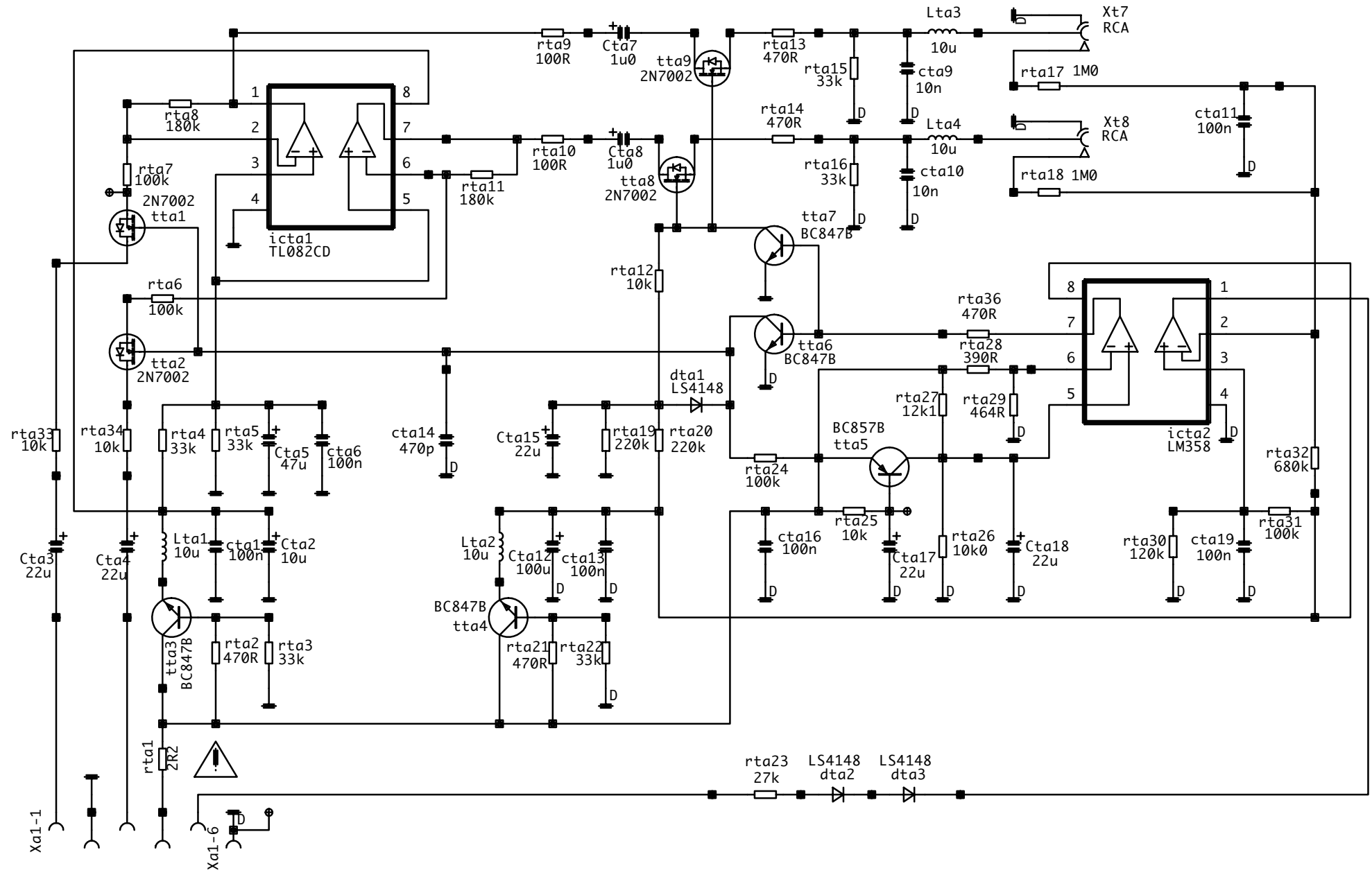

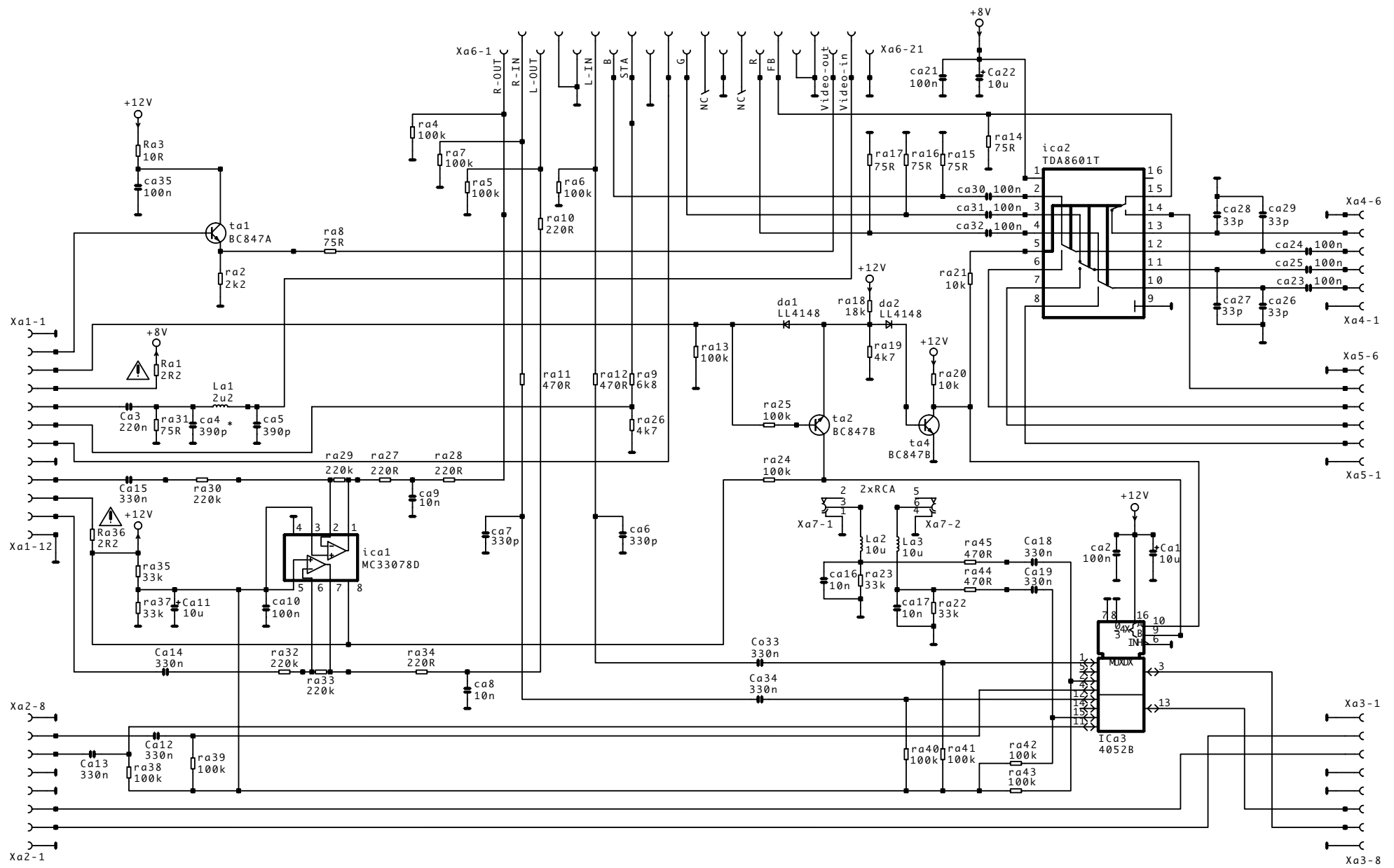

VD705 Vertical dumping module

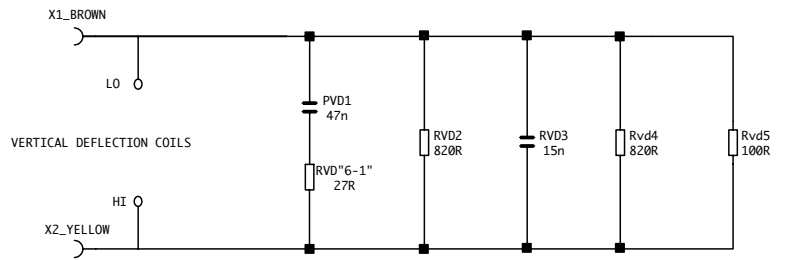
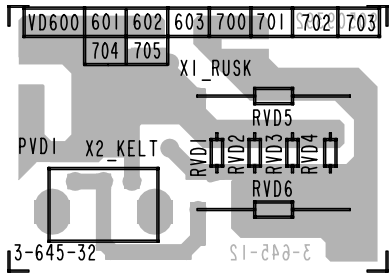

VD710 Vertical dumping module

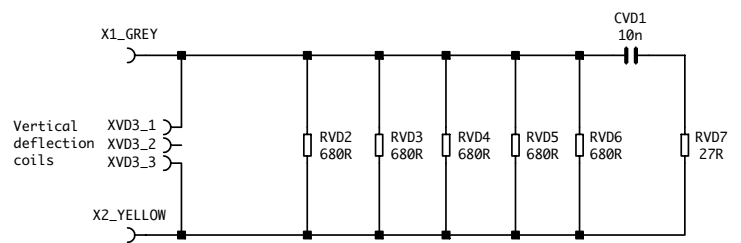
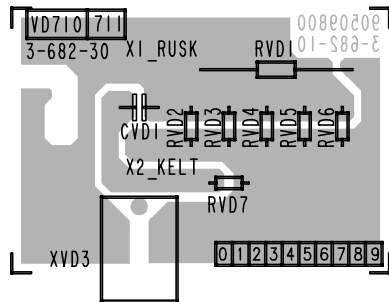

VM600 SVM-module

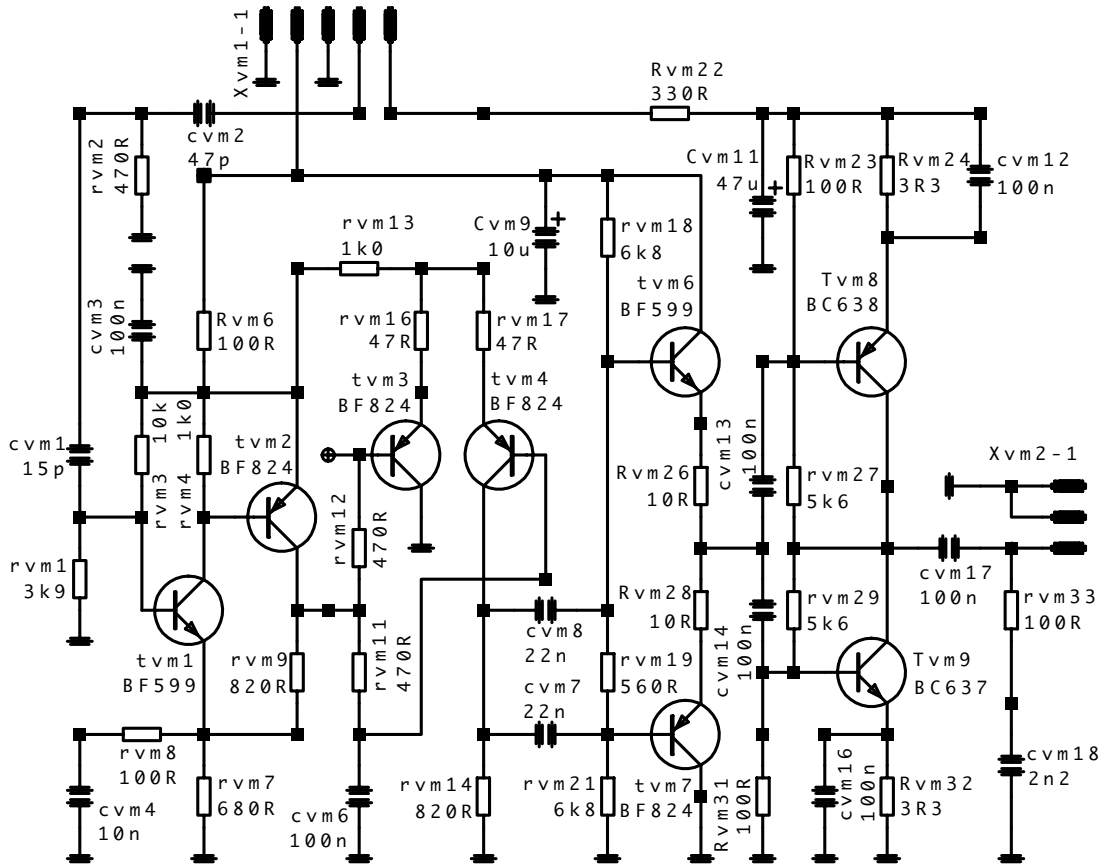
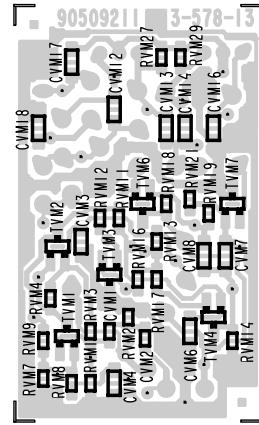
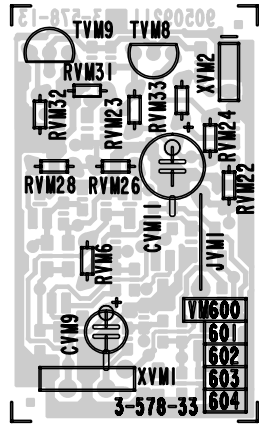

- Ⓒ **Variable components**
- Ⓓ **Röhrenabhängige Bauteile**
- Ⓔ **Komponentskillnader**
- Ⓕ **Composants variables**
- Ⓖ **Componenti che differiscono**

Picture tube	Vi 29 A68 EGD 038x322		Vi 29 VGA A68 EGD 038x322		Phi 28 A66 EAK 071x44		Phi 25 A59EAK 071x44	
Mainboard	MX***C*		MX***E*		MX***F*		MX***G*	
PW-block	PW700		PW709		PW711		PW712	
Rk3	4R7	31860002	4R7	31860002	8R2	31630090	8R2	31630090
Rk54	1R0	31850001	1R0	31850001	8R2	31630090	8R2	31630090
Rk55	1R0	31810014	1R0	31810014	3R0	31850007	3R0	31850007
Ro46	86k6	31440051	86k6	31440051	100k	31440014	100k	31440014
Rs2	1R21	31450008	1R21	31450008	1R1	31450013	1R1	31450013
Rs3	1R21	31450008	1R21	31450008	1R1	31450013	1R1	31450013
Rs11	390k	31630092	390k	31630092	680k	31548989	680k	31548989
Rt33	560R	31630047	560R	31630047	1k2	31518510	1k2	31518510
Ck24	13n	33450046	12n5	33460031	11n	33450054	11n	33450054
Ck25			330p	33460017	680p	33450053		
Ck27	330n	33450034			390n	33450040	330n	33450034
Ck28	4u7	33660002	4u7	33660002	470n	33450041	680n	33450048
Ck30	47n	33450036			120n	33241026	56n	33450061
Ck33			jumper 15					
Zdk3	15V	36770017	15V	36770017	18V	41003183	18V	41003183
Zds1	15V	36770017	15V	36770017	18V	41003183	18V	41003183
Mk1	1182.9001	45360020	1182.9001	45360020	1182.9018	45360036	1182.9018	45360036
MO2	FM3604	45320026	FM3604	45320026	FM3605	45320028	FM3605	45320028
Lk5	47uH	45620035			47uH	45620035	80uH	45620048
Lk6	47uH	45620035			jumper 5		jumper 5	
CRT-mod.	HH703	69137113	HH703	69137113	HH705	69137131	HH705	69137131
VD-mod.	VD705	69137111	VD705	69137111	VD710	69137130	VD710	69137130
UG2 cable	460mm	41314341	510mm	96010183	460mm	41314341	460mm	41314341
U1	130V (±1V)		130V (±1V)		140V (±1V)		140V (±1V)	

Spare parts

Ersatzteile

Reservdelar

Pièces de rechange

Parti di ricambio

Note! Hinweis! Obs! Remarque ! Nota!

- ⚠ Safety components in accordance with existing safety regulations. These components must be replaced only with original parts.
- ⚠ Sicherheitsbauteil im Sinn der Sicherheitsbestimmung. Diese Teile dürfen nur durch Originalteile ersetzt werden.
- ⚠ Skyddskomponenter. Dessa komponenter får endast ersättas med original reservdelar.
- ⚠ Composant de sécurité conformément aux réglementations de sécurité. Ces composants doivent être uniquement remplacés par des pièces d'origines.
- ⚠ Componenti di sicurezza ai sensi del regolamento di sicurezza. Queste componenti devono venir sostituite unicamente con parti originali.

- * Variable components
 * Röhrenabhängige Bauteile
 * Komponentskillnad
 * Composants variables
 * Componenti che differiscono

Main board

25"	Chassis MXEABG1	5863 1398
	Chassis MXRACG1	5863 1399
28"	Chassis MXEABF1	5863 1397
	Chassis MXRACF1	5863 1402
29"	Chassis MXEACCA	5863 1401
	Chassis MXREAEG	5863 1369

Item	Description	Order no.
RESISTORS 		
PK 1△	VRES FOCUS 59M 2W0	3128 0007
RA 1, 5, 115, 116	RES 2K2 0,125W CHIP	3142 5625
RA 2, 7, 25, 100	RES 10R 0,1W CHIP	3142 5810
RA 4, 6, 42, 46, 108	RES 4K7 0,1W CHIP	3142 5824
RA 8, 24	RES 1K 0,1W CHIP	3142 5820
RA 9, 10, 32, 38, 47, 48, 49	RES 10K 0,1W CHIP	3142 5833
RA 11, 12, 20, 21, 35, 36, 37	RES 33K 0,1W CHIP	3142 5840
RA 14	RES 100K 0,1W CHIP	3142 5844
RA 18△	RES 1R 4W	3143 0013
RA 22, 23	RES 270R 0,065W CHIP	3142 5855
RA 26, 27, 28, 29, 44, 45, 58, 104	RES 100R 0,1W CHIP	Standard
RA 31	R CARF 180R 5% 0W25 FP	3163 0026
RA 33, 39	R SMD 68K 5% 0W1	3142 5838
RA 34, 41	R CARF 47R 5% 0W25 FP	3151 4525
RA 51,52,53,54,56,57	RES 1M 0,1W CHIP	3142 5801
RA 61	RES 0R0 0,1W JUMPER	3142 5802
RA 107	S RES 10R 0,25W	3151 4513
RA 101, 109	RES 3K9 0,1W CHIP	3142 5830
RA 103, 110	R SMD 680K 5% 0W1	3149 0059
RA 102, 105, 106	RES 47K 0,1W CHIP	3142 5836
RD 1	RES 15K 0,1W CHIP	3142 5835
RD 2	R SMD 82K 5% 0W1	Standard
RD 3, 4	RES 270R 0,065W CHIP	3142 5855
RD 22, 23	RES 1K 0,1W CHIP	3142 5820
RF 1, 3, 4, 10, 13, 20, 28, 29	RES 10K 0,1W CHIP	3142 5833
RF 2, 42	RES 1K 0,1W CHIP	3142 5820
RF 6, 7	RES 270R 0,065W CHIP	3142 5855
RF 8, 11, 21	RES 4K7 0,1W CHIP	3142 5824
RF 9, 12	RES 100R 0,1W CHIP	Standard
RF 19	RES 220R 0,1W SMD	3142 5815

Item	Description	Order no.
RF 23, 41	R CARF 1K0 5% 0W25	3166 0016
RF 24, 26	R CARF 270R 5% 0W25	3166 0011
RF 30, 36, 48, 51	RES 0R0 0,1W JUMPER	3142 5802
RF 31	WID 0R0 0,125W CHIP JUMP	3142 5601
RF 40	RES 270R 0,25W FP	3163 0027
RF 43	RES 100K 0,1W CHIP	3142 5844
RF 46, 47	RES 47K 0,1W CHIP	3142 5836
RF 49	RES 2K2 0,125W CHIP	3142 5625
RF 52	R CARF 4K7 5% 0W25	3166 0031
RK 1	RES FUS 100K 1/4W	3163 0037
RK 2△	WID 1R5 5% 0W5 FP	3163 0014
RK 3△*	R FUS V 4R7 5% 0W25	3186 0002
RK 3△*, 54△*	RES 8R2 0W25 FP	3163 0090
RK 4△	SRES 27R 0,25W	3186 0001
RK 7	R CARF 1K0 5% 0W25	3166 0016
RK 8	R CF RD 150K J 1/4W	3163 0038
RK 9△, 19△	R FUS I 0R1 10% 0W4	3182 0003
RK 10	R CF RD 27K J 1/4W	3163 0035
RK 11, 12, 13, 14	R CF RD 5K6 J 1/4W	3163 0028
RK 15△	S RES 0R22 0,25W	3151 4506
RK 16, 51	R CARF 18K 5% 0W25	Standard
RK 17	R CF RD 6K8 J 1/4W	Standard
RK 20△	R FUS V 0R47 5% 0W5	3185 0004
RK 23△	SRES 2R2 0,25W	3151 4511
RK 24, 25	R CARF 150R 5% 0W25 FP	3163 0025
RK 27	RES 1K 0,1W CHIP	3142 5820
RK 28	SRES 100R 0,25W	3151 4516
RK 30	FUSE RES 1K5 0,25W	3151 4523
RK 34	RES 0R33 1,5W AX METOX	3143 0010
RK 36	RES 0R47 1,5W AX METOX	3143 0011
RK 38	R CARF 27R 5% 0W25	3166 0007
RK 39△	R FUS V 390R 10% 1W0	3185 0002
RK 41	R CARF 100K 5% 0W25	Standard
RK 42	RES 100K 0,1W CHIP	3142 5844
RK 43	RES 150R 0,1W CHIP	3142 5812
RK 44, 70	RES 10K 0,1W CHIP	3142 5833
RK 45△	R FUS V 27R K 1W0	3184 0003
RK 46, 47, 48	SWID 4K7 0,25W	3151 4522
RK 50	WID 39K 5% 0,25W	3163 0048
RK 53	RES 47K 0,1W CHIP	3142 5836
RK 54△*	R FUS V 1R0 5% 0W5	3185 0001
RK 55△*	SRES 1R0 0,7W	3181 0014
RK 55△*	SWID 3R0 0W50	3185 0007
RK 58	R CF RD 15K J 1/4W	3163 0033
RK 59	SRES 2R2 0W5	3185 0056
RK 60	RES 10R 0,1W CHIP	3142 5810
RO 1, 30	R WRLAC 1R5 5% 5W0	3136 0004
RO 2	R CARF 56R 5% 0W25 FP	3163 0046
RO 3	R METF 61K9 1% 0W6	3144 0013
RO 4	R SMD 1K00 1% 0W1	3149 0056
RO 5	PTC RS=24Ω FOR DEGAUS	3194 0001
RO 6	RES 220K 0,1W CHIP	3142 5847
RO 7	RES 10K 0,1W CHIP	3142 5833
RO 8, 14	RES 330K 0,25W 5% FP	3151 8658
RO 10	R SMD 562R F 0W10	Standard
RO 13	CARBON RE 27R 5% 0,25W F	3163 0021
RO 15	WID 22K 5% 0W25	3163 0034
RO 16	R WRLAC 33K 10% 9W0	3135 0002
RO 17	R CARF 1K0 5% 0W25	3166 0016
RO 18△	WID 0R47 0,6 W	3144 0019
RO 20	RES 220R 7W	3135 0013
RO 21△, 22△	R METF 0R27 5% 0W6	3144 0029
RO 23	R CARF 15R 5% 0W25 FP	3163 0020
RO 24	RES 6K81 0,6 W F METF	3145 0015
RO 26	R CARF 39R 5% 0W25 FP	3163 0023
RO 27	RES 2K2 0,1W CHIP	3142 5828
RO 28△	R COMP HV 10M 5% 0W5	3146 0001
RO 29△	R METOX 220R 5% 4W0	3143 0004
RO 31	R CARF 270R 5% 0W25	3166 0011
RO 32△	S RES 10R 0,25W	3151 4513
RO 34	F RES 10K 5% 0W25	3166 0022
RO 36	RES 22K 0,1W CHIP	3142 5837
RO 37	R METF 120K 1% 0W6	3144 0016

Item	Description	Order no.	Item	Description	Order no.
RO 38, 55	RES 4K7 0,1W CHIP	3142 5824	RT 29	RES 68R 5% CHIP	3142 5876
RO 39, 43, 51, 75	RES 47K 0,1W CHIP	3142 5836	RT 30	RES 3K9 0,1W CHIP	3142 5830
RO 42	R METF 2K05 1% 0W6	3144 0020	RT 31, 32	RES 1K5 5% SMD	3142 5826
RO 44	RES 56K2 0,6 W 1%	3144 0033	RT 33*	RES 1K2 0,25W FP	3151 8510
RO 45	R TRIM HOR 1K0 20% 0W1	3123 0005	RT 33*	R CF RD 560R J 1/4W	3163 0047
RO 46*	R METF 100K 1% 0W6	3144 0014			
RO 46*	R METF 86K6 F 0W60	3144 0051			
RO 47	R CARF 390R 5% 0W25 FP	3163 0041			
RO 48 Δ	R METOX 10R 5% 2W0	3143 0001			
RO 49 Δ	R FUS V 2R2 5% 0W25	3186 0003			
RO 50	R METF 4K32 1% 0W6	3144 0026			
RO 52	RES FUS 100K 1/4W	3163 0037			
RO 64	RES 150K 0,1W CHIP	3142 5846			
RO 65	RES 33K 0,1W CHIP	3142 5840			
RO 70	RES 10K 4W0 METOX	3144 0060			
RO 139, 141	R CF RD 180K J 1/4W	Standard			
RQ 1	RES 150R 0,1W CHIP	3142 5812			
RQ 2 Δ	S RES 10R 0,25W	3151 4513			
RQ 3, 59	RES 560R CHIP	3142 5818			
RQ 4, 65	RES 22K 0,1W CHIP	3142 5837			
RQ 8, 64, 72	RES 4K7 0,1W CHIP	3142 5824			
RQ 9, 11, 23, 24, 27, 33, 36, 43	RES 75R 0,1W CHIP	3142 5861			
RQ 10	RES 68R 5% CHIP	3142 5876			
RQ 12, 37	R CF RD 15K J 1/4W	3163 0033			
RQ 13, 17, 18, 21, 28, 29, 31, 32, 49, 58	RES 470R 0,1W SMD	3142 5817			
RQ 14, 16, 19, 22, 38, 39, 41, 42, 66, 80, 81, 82, 83	RES 100K 0,1W CHIP	3142 5844			
RQ 44,46,47,67,69,70	RES 220R 0,1W SMD	3142 5815			
RQ 48 Δ	R FUS V 4R7 5% 0W25	3186 0002			
RQ 50, 73	RES 47K 0,1W CHIP	3142 5836			
RQ 51	SRES 1K 0,25WV	3151 4519			
RQ 52, 53	RES 270R 0,065W CHIP	3142 5855			
RQ 54 Δ	R CARF 47R 5% 0W25 FP	3151 4525			
RQ 55	RES 27K 0,1 W CHIP	3142 5839			
RQ 56	R CARF 2K2 5% 0W25	3166 0037			
RQ 57	R CARF AX 100R 0W25	3166 0049			
RQ 60	RES 820R 0,1W CHIP	3142 5819			
RQ 61, 62, 74, 79, 85	RES 1K 0,1W CHIP	3142 5820			
RQ 63	R CARF 22K 5% 0W25	Standard			
RQ 68	RES 2K2 0,1W CHIP	3142 5828			
RQ 71	RES 56R 5% CHIP	3142 5865			
RQ 84	RES 1M 0,1W CHIP	3142 5801			
RR 1	RES 10K 0,1W CHIP	3142 5833			
RR 2, 14, 16, 17	RES 1K 0,1W CHIP	3142 5820			
RR 3, 4, 6	RES 3K9 0,1W CHIP	3142 5830			
RR 5	RES 100R 0,1W CHIP	Standard			
RR 7	RES 470R 0,1W SMD	3142 5817			
RR 8	RES 4K7 0,1W CHIP	3142 5824			
RR 10	RES 33K 0,1W CHIP	3142 5840			
RR 11, 12, 13	RES 560R 0W25	3166 0050			
RR 18	RES 0R0 0,1W JUMPER	3142 5802			
RR 18	R SMD 2R2 5% 0W1	Standard			
RS 1, 4	RES 1K2 0,125W	3142 5822			
RS 2*, 3*	R METF 1R21 1% 0W6	3145 0008			
RS 2*, 3*, 5	R METF 1R10 F 0W60	3145 0013			
RS 6	R SMD 180K 5% 0W1	3149 0012			
RS 7	SWID 22R 0,25 W	3151 4527			
RS 10	RES 100R 0,1W CHIP	Standard			
RS 11*	R SMD 680K 5% 0W1	3149 0059			
RS 11*	R SMD 390K 5% 0W25	Standard			
RS 15, 16, 17, 18	RES 2K7 0,125W	3142 5821			
RS 19	RES 3K3 0,1W CHIP	3142 5829			
RS 21	RES 100K 0,1W CHIP	3142 5844			
RT 10, 19, 20, 21	RES 1K 0,1W CHIP	3142 5820			
RT 11, 23	RES 47K 0,1W CHIP	3142 5836			
RT 12	RES 100K 0,1W CHIP	3142 5844			
RT 13, 14, 16	RES 100R 0,1W CHIP	Standard			
RT 15	RES 56K 0,1W CHIP	3142 5842			
RT 17, 18	R CARF 270R 5% 0W25	3166 0011			
RT 24	RES 10K 0,1W CHIP	3142 5833			
RT 25	RES 2K2 0,1W CHIP	3142 5828			
RT 26, 27	RES 220R 0,1W SMD	3142 5815			
RT 28	RES 470R 0,1W SMD	3142 5817			

CAPACITORS





CA 1	C ELYT 22U 20% 35V	Standard
CA 2, 3, 100, 102	C CER SMD 22N 10% 50V	3253 5914
CA 4,5,13,16,37,47,57,62,73,101,107,108	CAP 100NF 50V CER	3253 5920
CA 6	C ELYT 3300U 20% 35V	3451 0009
CA 9, 11	ECAP 470MF 35 V	3422 0648
CA 14, 17, 55, 59, 103	CAP 10NF 50V CHIP	3253 5918
CA 18, 29	C ELYT 1UF 63V	3454 0022
CA 22, 23, 24, 26	CAP 1NF 50V	3253 6203
CA 27,28,66,67,72,80	C CER SMD 390P 5% 50V	Standard
CA 30, 33, 34	CAP 47PF 50V CHIP	3212 5508
CA 31, 32	C CER SMD 1P2 5% 50V	3218 0008
CA 35,40,42,43,74,76	POLYESTER 330N 63V PAN 2	3312 7113
CA 36, 51, 52, 53, 54	C ELYT 22U 20% 35V	Standard
CA 38, 58	C ELYT 220UF 16V 13X17	3451 0003
CA 41, 48, 49, 56, 65	C ELYT 10U 20% 63V	3454 0025
CA 44, 45	C CER SMD 470P 5% 50V	Standard
CA 46	C ELYT 3U3 20% 63V	Standard
CA 60	C ELYT 47U 20% 16V	Standard
CA 104	C ELYT 22U 63V PAR	3454 0026
CA 105, 106, 109, 110	C MKT 220N 10% 63V	3312 7108
CD 11	POLYESTER 470N 10% 63V	3312 7123
CD 12, 16	C CER SMD 3N3 10% 50V	Standard
CD 13,14,19,21,22,24,26,27,28,29,31	CAP 100NF 50V CER	3253 5920
CD 17, 18	CAP 18 PF 50V CHIP	3212 5520
CD 23	C EL RD 100U M 25V	3454 0020
CF 1, 3, 5, 14, 15, 20	CAP 100NF 50V CER	3253 5920
CF 2	C ELYT 47U 20% 16V	Standard
CF 6, 7	CAP 33PF 50V CHIP	Standard
CF 10, 13	CAP 100PF 50V	3212 5515
CF 21	C ELYT 2U2 20% 63V	3454 0023
CK 1	C MKT 100N 10% 250V	3336 0003
CK 2	C ELYT 4U7 250V 11x13 HV	3461 0001
CK 3, 18	C CER 330P 10% 500V	3278 0002
CK 4	C CER 2N2 20% 500V	3278 0003
CK 6	C CER 150P 10% 500V	3278 0001
CK 7, 8	C MKC 330N 10% 250V	3366 0001
CK 9	C ELYT 22U 63V PAR	3454 0026
CK 11	C ELYT 2200U 20% 25V	3451 0005
CK 12, 14, 15	POLYESTER 100n 10% 63V	3312 7106
CK 13	C EL RD 100U M 25V	3454 0020
CK 16	C CER 56P 5% 50V	Standard
CK 17, 31	C MKT 220N 10% 63V	3312 7108
CK 21, 32	POLYESTER 470N 10% 63V	3312 7123
CK 22	C MKP 470P 2.5% 1K6V	3346 0011
CK 23	C (M)KP 15N 2,5% 100V	3346 0003
CK 24*	CAP 13NF	3345 0046
CK 24*	CAP 11NF	3345 0054
CK 24*	C MKP 12N5 3,3% 1K6V	3346 0031
CK 25*	CAP 680PF	3345 0053
CK 25*	C (M)KP 330P 10% 1K6V	3346 0017
CK 26	COND 15NF 2,5% 630V	3346 0023
CK 27*	C MKP 330N J 250V	3345 0034
CK 27*	C 390NF 250V	3345 0040
CK 28*	C 470NF 250V	3345 0041
CK 28*	CAP 680N 250V 9R FOIL	3345 0048
CK 28*	C MKC 4U7 10% 63V	3366 0002
CK 30*	SCAP 120N 400V	3324 1026
CK 30*	C MKP 47N 3.5% 400V	3345 0036
CK 30*	SCAP 56N 400V	3345 0061
CK 36	POLYESTER 330N 63V PAN 2	3312 7113
CO 1	C MKT 220N 10% 400V	3336 0002
CO 3 Δ , 4 Δ	SCAP 1 NF 4KV	3261 0931
CO 6, 7, 8, 9	SCAP 1,5 NF 2KV	3267 0976
CO 10	C ELYT 220U 20% 385V	3426 0826
CO 11	C MKP 33N 5% 1KV	3346 0016
CO 12	C MKT 10N 5% 400V	3336 0006

Item	Description	Order no.
CO 13	CAP 680PF	3345 0053
CO 14	C ELYT 2U2 20% 63V	3454 0023
CO 15	C ELYT 100u 35V 13x21 R	3451 0006
CO 16	CAP 1N0 5% 63V	3348 0010
CO 17	POLYESTER 330N 63V PAN 2	3312 7113
CO 18, 29	CAP 100PF 50V	3212 5515
CO 19, 74	CAP 220 PF 50V	3212 5513
CO 21	C CER SMD 33N 20% 50V	Standard
CO 22	C MKT 1U0 10% 63V	3312 4758
CO 23,26,42,43,62,64	CAP 100NF 50V CER	3253 5920
CO 28	POLYESTER 470N 10% 63V	3312 7123
CO 31	C (M)KP 330P 10% 1K6V	3346 0017
CO 32	C MKT 100N 10% 250V	3336 0003
CO 33	C ELYT 100U 20% 200V	3461 0006
CO 34, 49	C CER 330P 10% 500V	3278 0002
CO 36, 41	C ELYT 1000U 20% 35V	3451 0013
CO 37,39,40,46,51,71	POLYESTER 100n 10% 63V	3312 7106
CO 38, 44	C CER 1N0 10% 500V	3278 0004
CO 50, 53, 54, 61	C ELYT 1000U 20% 16V	3451 0004
CO 55	C EL RD 100U M 25V	3454 0020
CO 56 [△]	C CER 1N5 20% 400VAC	3296 0002
CO 57, 69	C ELYT 10U 20% 63V	3454 0025
CO 58	C CER SMD 47N 10% 50V	Standard
CO 60	CAP 1NF 50V	3253 6203
CO 63, 79	C MKT 220N 10% 63V	3312 7108
CO 65	C ELYT 22U 20% 35V	Standard
CO 72	C CER SMD 470P 5% 50V	Standard
CO 73	C CER SMD 4N7 10% 50V	Standard
CO 76	C ELYT 22U 63V PAR	3454 0026
CO 81	CAP 33PF 50V CHIP	Standard
CQ 1, 32	C ELYT 10U 20% 63V	3454 0025
CQ 2, 3, 4, 6, 7, 9, 12, 13, 14, 17, 38	C CER SMD 390P 5% 50V	Standard
CQ 8, 11, 16, 18, 23	CAP 10NF 50V CHIP	3253 5918
CQ 10	C ELYT 22U 63V PAR	3454 0026
CQ 15	C EL RD 100U M 25V	3454 0020
CQ 19, 20, 21, 22, 27, 28, 29, 30, 41	CAP 100NF 50V CER	3253 5920
CQ 24, 25, 31	C ELYT 2U2 20% 63V	3454 0023
CQ 26	C ELYT 47U 20% 16V	Standard
CQ 33	CAP 220 PF 50V	3212 5513
CQ 34	CAP 10PF 50V SMD	3212 5506
CQ 35	C MKT 220N 10% 63V	3312 7108
CQ 37	CAP 1 NF 50V CHIP	3253 5901
CQ 39	CAP 22PF 50V	3212 5521
CQ 40	C CER SMD 22N 10% 50V	3253 5914
CQ 45	CAP 330PF 50V	3212 5517
CR 1, 2	CAP 33PF 50V CHIP	Standard
CR 3,4,5,6,7,11,12,14	CAP 100NF 50V CER	3253 5920
CR 8	C ELYT 10U 20% 63V	3454 0025
CR 9	C ELYT 22U 20% 35V	Standard
CR 10	POLYESTER 470N 10% 63V	3312 7123
CR 13	C EL RD 100U M 25V	3454 0020
CS 1	C ELYT 47UF M 63V	3454 0053
CS 2	ECAP 220MF 25V	3422 9784
CS 3	POLYESTER 470N 10% 63V	3312 7123
CS 4, 6	CAP 10 NF 50V CHIP	3253 6213
CS 7	CAP 10N 250V	3345 0057
CS 8	CAP 220 PF 50V	3212 5513
CS 9	POLYESTER 100n 10% 63V	3312 7106
CS 10	CAP 100NF 50V CER	3253 5920
CT 1,2,3,9,14,37,44	CAP 10NF 50V CHIP	3253 5918
CT 4, 24, 39	CAP 100NF 50V CER	3253 5920
CT 19	C CER SMD 47N 10% 50V	Standard
CT 21	C ELYT 22U 63V PAR	3454 0026
CT 22	C ELYT 1UF 63V	3454 0022
CT 23	POLYESTER 330N 63V PAN 2	3312 7113
CT 26, 27, 28	POLYESTER 470N 10% 63V	3312 7123
CT 29	C ELYT 10U 20% 63V	3454 0025
CT 31	C ELYT 4U7 20% 63V	Standard
CT 38	CAP 47PF 50V CHIP	3212 5508
CT 40	C MKT 1U0 10% 63V	3312 4758
CT 42, 43	C CER SMD 390P 5% 50V	Standard

Item	Description	Order no.
TRANSISTORS 		
TA 3, 5, 6, 8, 9, 10	BC847B	3614 5312
TA 4	BC857B CHI	3614 5412
TK 1	BC547B 45V 10	3622 0002
TK 2	BC637 60V 1a	3622 0003
TK 3	BU2525AF 1K5V	3627 0003
TK 4	2SD2012 60v	3627 0004
TK 6	BC857B CHI	3614 5412
TO 1	IRFBC40 600V	3637 0001
TO 4	BUK483 60A 60V	3638 0001
TO 6, 7	BC847B	3614 5312
TO 8	2SD2012 60v	3627 0004
TO 9	BC547B 45V 10	3622 0002
TO 10	BC857B CHI	3614 5412
TO 15	THYRISTOR MCR100-6 400V	3610 0001
TQ 1	BC547B 45V 10	3622 0002
TQ 2	BC557B	3614 6424
TQ 3,4,6,7,8,9,10,11	BC847B	3614 5312
TQ 5	BC337-25	3614 7138
TS 1, 2	BC858C	3614 5423
TT 1, 3	BC847B	3614 5312
TT 2, 4	BC857B CHI	3614 5412

Item	Description	Order no.
DIODES 		
DA 1	SMD LS4148 75V 200MA	3649 0002
DF 1, 2, 3, 4, 5	SMD LS4148 75V 200MA	3649 0002
DK 1	BYV26C 600V 1	3661 0005
DK 2, 6	BYV36C 600V 1	3657 5452
DK 3	BYW 98-200	3657 5470
DK 4, 5, 11	1N4148 75V 200MA DO35	3642 0002
DK 7	BY359F 1K5V 5	3657 1465
DK 8	BY229F 800V 7	3661 0004
DO 1, 2, 3, 4	BY527 1K25V 2	3661 0001
DO 5	BYS21-90V 1,0A	3662 1556
DO 6, 8, 9	1N4937	3657 5353
DO 7	BYV36C 600V 1	3657 5452
DO 11	DI RECT BYM36D 800V 2.9A	3662 1551
DO 12, 13	BYW 98-200	3657 5470
DO 14, 16	SB545S 45V 5A	3642 0003
DO 17, 18, 20	1N4148 75V 200MA DO35	3642 0002
DQ 4	BAV70 SMD	3656 1954
DS 1, 2	1N4148 75V 200MA DO35	3642 0002

Item	Description	Order no.
ZENERS 		
DZO 21	BZX85C 20V	3677 0006
ZDA 1	BZX83B 8V2 2% DO35	3677 0009
ZDA 2	BZX84A 12V 1%	3677 0019
ZDK 1	BZX83B 30V	3677 0005
ZDK 2	BZX83C 8V2	3677 0003
ZDK 3*	BZX79C 18V 5% 400MW	3656 3947
ZDK 3*	BZX83C 15V	3677 0017
ZDO 1	BZX84C 8SMD	3678 0003
ZDO 21	BZX85C 20V	3677 0006
ZDQ 1	BZX83C 10V 5% DO35	3677 0002
ZDQ 2, 3	BZX84C 8SMD	3678 0003
ZDR 1	BZX83C 3V3 5% DO35	3677 0001
ZDS 1*	BZX79C 18V 5% 400MW	3656 3947
ZDS 1*	BZX83C 15V	3677 0017
ZDS 2	BZX84C2V4	3678 0005
ZDT 3	DIODE BZX83B 30V	3677 0005

Item	Description	Order no.
INTEGRATED CIRCUITS 		
ICA 1, 4	TDA2616A	3763 1259
ICA 2	MSP3410D-B3	3743 0023
ICA 3	MC33078N	3747 0006
ICD 1	TDA9143-N2	3744 0056
ICD 3	TDA4665	3741 0008
ICF 1	EPROM MCAA06.0	3779 2347
ICF 2	X24C16P EEPROM 8X256X	3786 0015
ICF 3	SDA30C264M2 SMD	3785 7014
ICF 4	74HCT08 SO14 SMD	3781 0023

Item	Description	Order no.
ICF 5	TL7705A	3746 0011
ICO 1	TEA2262 PWR	3745 0002
ICO 2	TEA 5170	3766 1173
ICO 3	PQ12RH11 12V	3746 0007
ICO 4	LM2940 CTV	3768 1840
ICO 6	PQ05RH11 5V	3746 0008
ICQ 1	TEA6417 DIL20	3744 0012
ICR 1	SDA5273S/C 134	3785 7004
ICR 1	SDA5275	3785 7006
ICR 2	DRAM HYB514400BT-70T	3786 2004
ICS 1	TDA8354-N1E	3745 0016
ICT 1	TDA4780 V1C DIL	3744 0003

FUSES

FO 1 Δ	FUSE F2,5A MINIATURE D=8	4377 0004
FO 2 Δ , 3 Δ	FUSE T2,0A MINIATURE D=8	4377 0005

TRANSFORMERS

MK 1 Δ *	DST TRAF0 1182.9001	4536 0020
MK 1 Δ *	DST TRAF0 1182.9018	4536 0036
MK 2	TRANSFORMER FH2543	4538 0013
MK 3	COIL 68UH 15%	4538 0024
MO 2 Δ *	MAINS TRAF0 FM3604	4532 0026
MO 2 Δ *	MAINS TRAF0 FM3605	4532 0028
MO 3 Δ	TRAF0 TM2633 PULSE	4532 0035

COILS

LA 1, 2, 4, 5, 6, 7	CHOKE 10 UH	4557 1699
LA 3	COIL 10UH 10% 230MA	4563 0002
LF 1, 2	COIL 10UH 10% 230MA	4562 0003
LF 3	CHOKE 10 UH	4557 1698
LK 1	COIL 1,9MH	4561 0018
LK 2	COIL FU 1206	4538 0010
LK 5*	COIL 82UH 1400MA	4562 0048
LK 5*, 6*	CHOKE 47 UH 7% 2A	4562 0035
LK 6*	JUMPER R=5,0MM TL0.6	4131 4440
LK 7	COIL 10UH 10% 230MA	4562 0003
LO 3, 4	CHOKE 10 UH	4557 1699
LO 1, 2, 5, 6, 7	EMI SUPPRES BEAD 3.5X9	4562 0007
LQ 1, 2, 3	COIL 2.2UH 10% 520MA	4563 0003
LQ 6, 7	CHOKE 10 UH	4557 1699
LR 1	CHOKE 10 UH	4557 1699

CRYSTALS

ZA 1	QUARTZ 18.432MHZ	4571 0011
ZD 1	QUARTZ 4433.619KHZ	4573 0002
ZD 2	QUARTZ 3.57954MHZ	4573 0001
ZF 1	CRYSTAL 12.0MHZ	4573 0005
ZR 1	QUARTZ 20.48MHZ	4573 0004

OTHERS

TU 1*	HF-IF MODULE SR701	5825 8841
TU 1*	HF-IF MODULE SR702	5825 8842

DB-MODULE

DK 7, 8	GROUNDING SPRING	8488 0172
ICA 1, 4	CLIP	8681 7341
ICF 1	CLIP	8681 7341
ICO 3, 6	IC SOCKET DIL32	4152 0751
ICS 1	FASTENING SPRING	7358 4994
TK 3	TENSION SPRING	7368 7012
TK 4	CLIP	8681 7341
TO 1	FASTENING SPRING	7358 4994
TO 1	ISOLATOR TO-220	8231 8802
TO 1	CLIP	8681 7341
TO 8	FASTENING SPRING	6157 2387
UFC 1-1	MAIN SWITCH	4121 0004
UG 2*	SCREEN CABLE 460mm	4131 4341
UG 2*	SCREEN CABLE 510mm	9601 0183
X1GR - X2YE	WIRE BUNDLE PK/Z MX	4889 9838
XATA	CABLE SET 6-N L=75	4758 5005
XEXTS	SOCKET-LP	4145 0612

Item	Description	Order no.
XQ 2	SCART CONNECTOR BLUE	4191 0004
XQ 3	SCART-SOCKET	4145 0292
XQ 7	WIRE BUNDLE 6-PIN 200mm	4889 9808
XQ 7	CABLE HOLDER	8448 6030

AJ602 Crossover network

R 1	CARF 3R9 5% 0W5	3165 0001
C 1	C ELYT 4U7 20% 50V	3454 0034
C 2	C ELYT 2U2 20% 50V	3454 0052
	COIL 36-18	4543 4221
	ROW CONNECTOR 2-P	7319 1101

AR700 3D-sound module**RESISTORS**

RAR 1	RES 2,2K 0,1W CHIP	3142 5828
RAR 2	RES 1 K 0,1W CHIP	3142 5820
RAR 3	RES 220K 0,1W CHIP	3142 5847
RAR 4, 14	RES 10K 0,1W CHIP	3142 5833
RAR 5, 6, 7, 8, 9, 10	RES 100E 0,1W CHIP	Standard

CAPACITORS

CAR 1	CAP 18 PF 50V CHIP	3212 5520
CAR 2, 3, 4, 5, 6, 7, 8, 9, 10, 11, 12, 13	C CER SMD 100N K 25V	3279 0018
CAR 14	ECAP 220UF 10V RAD 6X11	3454 0018
CAR 15	CAP 1NF 50V	3253 6203

INTEGRATED CIRCUITS

ICAR 1	SMD-IC 74HC04 SO-14	3781 0010
ICAR 2	TMS57053 SMD	3787 0013
ICAR 3	SRAM 32KX8GM76C256A	3786 0025

OTHERS

TAR 1, 2	N-FET SMD 2N7002 60V 180	3638 0002
LAR 1	CHOKE 10 UH	4557 1699

CF700 Comb filter module**RESISTORS**

RC 3, 7, 41	RES 10K 0,1W CHIP	3142 5833
RC 4	RES 3,3K 0,1W CHIP	3142 5829
RC 6, 16	RES 220E 0,1W SMD	3142 5815
RC 8, 9, 44, 46	RES 2,2K 0,1W CHIP	3142 5828
RC 11	RES 47 K 0,125W CHIP	3142 5615
RC 12	RES 1 K 0,1W CHIP	3142 5820
RC 13	RES 390E 0,1W CHIP	3142 5816
RC 14, 17	RES 560 E CHIP	3142 5818
RC 15	RES 1,2K 0,125W	3142 5822
RC 18	RES 10K 0,125W	Standard
RC 19	RES 820K 0,1W	3142 5885
RC 20	RES 180E 0,1W CHIP	3142 5854
RC 23	RES 470 E 0,1W SMD	3142 5817
RC 24, 43, 48	RES 100E 0,1W CHIP	Standard
RC 39	RES 39K 0,1W CHIP	3142 5841
RC 40	RES 6,8K 0,1W CHIP	3142 5831
RC 42	RES 47K 0,1W CHIP	3142 5836
RC 45, 47	RES 330E 0,1W 5% CHIP	3142 5857
RC 49	R SMD 47R 5% 0W1	3142 5809

CAPACITORS

CC 3, 11, 41, 44	CAP 10PF 50V SMD	3212 5506
CC 5	C CER SMD 1N0 2% 50V	Standard
CC 12, 17, 21, 23, 33	C ELYT 47U 20% 50V	3454 0028

Item	Description	Order no.
CC 13, 20, 22, 29	CAP 100NF 50V CER	3253 5920
CC 18,26,28,32,40,48	C CER SMD 100N K 25V	3279 0018
CC 24, 27, 47	C ELYT 10U 20% 63V	3454 0025
CC 31	C CER SMD 470N 80/20% 50	Standard
CC 35, 36	C CER SMD 56P 5% 50V	Standard
CC 38, 42, 45	C CER SMD 68P 5% 50V	Standard
CC 43, 46	CAP 22PF 50V	3212 5521

TRANSISTORS



TC 3, 7, 9, 10	TRANS BC 847B	3614 5312
TC 4, 6, 8, 11, 12	TRANS BC 857B CHI	3614 5412
TC 5	TR NPN SMD BF599 25V 25M	3628 0003

INTEGRATED CIRCUITS



IC 1	IC HEF 4053BT MOS	3771 5194
IC 2	IC MC141627 QFP48	3744 0054

COILS



LC 1, 5, 6	CHOKE 10 UH	4557 1699
LC 2	COIL 15UH 10% 610MA	4563 0004
LC 3, 7, 8	COIL 10UH 10% 230MA	4563 0002
LC 4	COIL 6,8 UH K 250MA RAD	4562 0017

DB700/710 Feature module

RESISTORS



RDB 1, 2, 71, 91	RES 820R 0,1W CHIP	3142 5819
RDB 3, 107, 108, 109	RES 75R 0,1W CHIP	3142 5861
RDB 4, 103	RES 10R 0,1W CHIP	3142 5810
RDB 5, 12, 15, 22, 25, 32, 66, 144, 145, 146	RES 15K 0,1W CHIP	3142 5835
RDB 6,13,16,23,73,75	RES 4K7 0,1W CHIP	3142 5824
RDB 7, 17, 27, 155	R SMD 22R 5% 0W1	Standard
RDB 8, 10, 14, 18, 20, 24, 28, 30	RES 470R 0,1W SMD	3142 5817
RDB 9, 21, 29	RES 180R 0,1W CHIP	3142 5854
RDB 19	R SMD 240R 5% 0,065W	3149 0085
RDB 31,102,11,113,118	RES 220R 0,1W SMD	3142 5815
RDB 33, 177, 26	RES 3K9 0,1W CHIP	3142 5830
RDB 34	RES 560R CHIP	3142 5818
RDB 62, 157, 158	RES 2K2 0,1W CHIP	3142 5828
RDB 63	RES 39K 0,1W CHIP	3142 5841
RDB 64	RES 33K 0,1W CHIP	3142 5840
RDB 68	RES 39K 0,1 W 2% SMD	3149 0005
RDB 69,70,80,81,153,154, 178,179,212,213	RES 100R 0,1W CHIP	Standard
RDB 72	RES 100K 0,1W CHIP	3142 5844
RDB 84, 86, 195, 209, 210, 211	RES 0R0 0,1W JUMPER	3142 5802
RDB 94,95,96,97,98,99	R SMD 200R 5% 0W1	3149 0067
RDB 100, 101, 104	RES 150R 0,1W CHIP	3142 5812
RDB 105, 115, 116, 117	RES 33R 0,1W CHIP	Standard
RDB 106	RES 1M 0,1W CHIP	3142 5801
RDB 114, 119	RES 330R 0,1W 5% CHIP	3142 5857
RDB 120, 214, 215, 67	RES 10K 0,1W CHIP	3142 5833
RDB 150, 152, 156, 159, 160, 161, 191, 192, 193, 194	RES 1 K 0,1W CHIP	3142 5820
RDB 151, 65	RES 3K3 0,1W CHIP	3142 5829

CAPACITORS



C 212	ECAP 10MF 16V	3422 3249
C 214	C ELYT 4U7 20% 63V	Standard
CDB 3,5,8,11,12,14,17,19, 20,21,22,23,24,25,27, 28,29,30,34,35,38,39, 40,41,42,44,45,47,48, 50,52,54,56,63,73,83, 91,98,101,102,103,		

Item	Description	Order no.
104,105,112,120,122, 153,164,166,217	CAP 100NF 50V CER	3253 5920
CDB 18, 36, 37, 49, 62, 72, 80, 82, 121, 163, 165, 216	C EL RD 100U M 25V	3454 0020
CDB 43, 46, 60, 70, 90	C ELYT 22U 20% 16V	Standard
CDB 51	C ELYT 47U 20% 50V	3454 0028
CDB 53, 55, 69, 79, 89, 213, 215	C ELYT 1UF 63V	3454 0022
CDB 57, 58, 59	CAP 1NF 50V	3253 6203
CDB 61,71,81,210,211	CAP 10NF 50V CHIP	3253 5918
CDB 64, 74, 86, 151	CAP 82PF 50V CHIP	3212 5531
CDB 65, 75	CAP 6,8PF 50V SMD	3219 0009
CDB 66, 76	CAP 180P 50V 2% SMD	3219 0019
CDB 67, 77, 95, 96, 115, 203	CAP 22PF 50V	3212 5521
CDB 68, 78, 88	C CER SMD 68P 5% 50V	Standard
CDB 84	CAP 33PF 50V CHIP	Standard
CDB 85	C CER SMD 5P6 5% 50V	3219 0017
CDB 111, 119, 150, 204	CAP 100PF 50V	3212 5515
CDB 114	CAP 18 PF 50V CHIP	3212 5520
CDB 116, 117, 118	C CER SMD 3P9 5% 50V	3219 0015
CDB 139	CAP330NF 25V SMD	3279 0002
CDB 152	C CER SMD 120P 5% 50V	Standard
CDB 160, 161, 162	C CER SMD 470N 80/20% 50	Standard
CDB 167, 168, 169	CAP 2N2 50V 2% SMD	3219 0026
CDB 202	C CER SMD 12P 5% 50V	Standard
CDB 205, 209	CAP 39PF 50V	3212 5512
CDB 206	CAP 10PF 50V SMD	3212 5506
CDB 207	CAP 15 PF 50V	3212 5510
CDB 208, 87	CAP 27PF 50V CHIP	3212 5509

TRANSISTORS



T 16, 17	N-FET SMD 2N7002 60V 180	3638 0002
TDB 1, 9, 13, 14, 15	BC847B	3614 5312
TDB 2, 3, 4, 5, 6, 7	BFS20 R	3612 0719
TDB 18	NPN SMD BF599 25V 25M	3628 0003
TDB 19	BF824 CHI	3612 0751

INTEGRATED CIRCUITS



ICDB 1	PQ05RH11 5V	3746 0008
ICDB 2	LOGIG SMD 74F14 SO14	3781 0005
ICDB 3	EEPROM 24LCS21A SMD	3786 6003
ICDB 4	LD1117DT33 3V3 SMD	3746 0023
ICDB 9	TLC5733	3788 0013
ICDB 10	IQT V2.1 SMD	3787 7005
ICDB 11	DP11.02 SMD	3787 7004
ICDB 14, 24	TMS YC2972	3786 2003
ICDB 17	TDA9151 N3 DIL20	3745 0001
ICDB 28	74F30 SO14 SMD	3781 0021

COILS















LDB 1, 2, 14, 15, 16	CHOKE 10 UH	4557 1699
LDB 3, 4, 5, 13, 17	COIL SMD 10UH 10% 180MA	4564 0002
LDB 6, 8	COIL 33UH 5MA SMD	4562 0041
LDB 7, 9	COIL 27UH 5MA SMD	4562 0040
LDB 10, 11, 12	COIL SMD 12UH 10% 15MA	4564 0005
LDB 26	COIL 1.5UH SMD	4564 0018
LDB 27	COIL 3,3 UH	4543 4016
LDB 28, 29	COIL 2,2UH 10% 270MA SM	4564 0001
LDB 30	CHOKE 10 UH	4557 1699

OTHERS



QDB 9	DIODE LS4148 75V 200MA	3649 0002
ZDB 1	QUARTZ 27.000MHZ	4573 0007
QB 101, 102	CONNECTEUR FEM 16C	4145 8102
QB 104	CONN D-TYPE 15-N VGA	4172 0017
QB 105	CABLE ASS 6-P 230mm	4758 0085
	FRONT PANEL-2 FEATURE BOX	8357 8805
	BOTTOM FEATURE BOX	8357 8807
	COVER FEATURE BOX	8681 7492

Item	Description	Order no.
FC700 Control module		
RESISTORS 		
RFC 1, 2, 10, 32	RES 47K 0,125W CHIP	3142 5639
RFC 3, 4	RES 75R 0.25W CHIP	3142 5669
RFC 9	R SMD 270R J 0W25	3142 5613
RFC 11, 16	RES 15K 0,125W CHIP	3142 5637
RFC 12,31,38,41,43,47	RES 1K 0,125W SMD	3142 5622
RFC 13	R SMD 330R J 0W25	3142 5614
RFC 14, 46	RES 100K 0,125W CHIP	3142 5646
RFC 15, 19, 20, 37, 39	RES 10K 0,125W	Standard
RFC 21, 22	R CARF 2K2 5% 0W25	3166 0037
RFC 23, 24	RES 220R	3163 0051
RFC 26, 27	R CARF AX 100R 0W25	3166 0049
RFC 28	0W25 330R 5% R CARF	3166 0012
RFC 29	RES 4K7 0,125W CHIP	3142 5629
RFC 33, 34	RES 560K 0W25 SMD	3142 5683
RFC 45, 48, 49	R SMD 1M8 J 0W25	Standard
RFC 42	RES 1K8 0W25 SMD	3142 5620
CAPACITORS 		
CFC 1△, 2△	C MP/P 100N M 275VAC	3326 0003
CFC 5, 7	C CER SMD 4N7 10% 50V	Standard
CFC 8, 20, 28	C ELYT 10U 20% 35V	3454 0027
CFC 9, 10, 12, 13	CAP 390P 5% 50V SMD CER	3212 5646
CFC 11,16,17,18,19,32	CAP 10NF 50V CHIP	3253 5918
CFC 14, 15	C EL RD 100U M 25V	3454 0020
CFC 21, 22	C CER 15P 5% 50V	Standard
CFC 23	C ELYT 220UF 16V 13X17	3451 0003
CFC 24, 26	CAPACITOR 0,33MF 250V	3324 0928
CFC 27	C ELYT 22U 20% 35V	Standard
CFC 29, 31	C ELYT 1UF 63V	3454 0022
CFC 35	ECAP 470MF 10V	3422 1242
TRANSISTORS 		
TFC 1, 2	BC857B	3614 5412
TFC 3, 6	BC847B	3614 5312
DIODES 		
DFC 4	LED LS5460HL	3691 0004
DFC 6, 7, 8, 9	BY527 1K25V 2	3661 0001
DFC 11	TRC BT137 600V 8A	3610 4002
DFC 12, 13	SMD LS4148 75V 200MA	3649 0002
DFC 16	LED TLDR4900 RED 3MM	3691 0014
DFC 17	LED LG5460GK	3691 0005
DFC 18	BAV 70 SMD	3656 1954
DZFC 1	ZDIODE BZX83C 5V1 5% 400	3656 3937
INTEGRATED CIRCUITS 		
HFC 1, 2	IR RECEIVER SFH506 38	3694 0001
ICFC 1	HEF4011BP MOS	3771 0240
ICFC 3△, 4△	OPTO COUPL TCDT1101G	3695 0003
ICFC 5	TLP168J 11-4C3	3695 0006
COILS 		
LFC 1, 2	SPULE 39UH M 2500MA	4562 0044
LFC 3, 4, 7, 8, 9	COIL 10UH 10% 230MA	4563 0002
LFC 5, 6	COIL 2.2UH 10% 520MA	4563 0003
MFC 1-1△	COIL MAINS TJ1853	4539 0013
OTHERS 		
FFC 1△	FUSE T3.15A HIGH BREAK 5	4375 1652
DFC 11	FASTENING SPRING	6157 2387
FFC 1	FUSEHOLDER CLIPS5X20mm	4154 0001
SWFC 1, 2, 3, 4	SWITCH, MICRO 4X	4115 0685
UFC 1-1△	MAIN SWITCH	4121 0004
XA 5	WIRE BUNDLE 12PIN	4889 9807

Item	Description	Order no.
XA 4	WIRE BUNDLE 8-PIN 600mm	4889 9815
XFC 10	CONN. PHONO 3.5mm JACK	4191 0001
XFC 9-4	CONN. S-VHS	4145 2244
XFC 6-3	SOCKET CYNCH 3FOLD	4143 0747
	MODULE SUPPORT	8681 5351
	TOUCH PROTECTION	8448 0160
FC710 Control module		
RESISTORS 		
R 1, 2, 10, 17	R SMD 47K J 0W25 1206	31425639
R 3, 4	R SMD 75R J 0W25 1206	31425669
R 7, 12	R SMD 1K0 J 0W25 1206	31425622
R 8, 9	R SMD 270R J 0W25 1206	31425613
R 11, 16, 18	R SMD 15K J 0W25 1206	31425637
R 13	R SMD 330R J 0W25 1206	31425614
R 14	R SMD 100K J 0W25 1206	31425646
R 15, 19, 20	R SMD 10K J 0W25 1206	31425635
R 21, 22	R CARF AX 2K2 5% 0W25	31660037
CAPACITORS 		
C 1△, 2△	C MP/P BLK 100N M 275VAC	33260003
C 5, 7	C CER2 SMD 4N7 K 50V	32790007
C 8, 20	C ELYT RAD 10U M 35V	34540027
C 10, 13	C CER1 SMD 390P J 50V	32125646
C 11	C CER2 SMD 1N0 K 50V	32535901
C 14, 15	C ELYT RAD 100U M 25V	34540020
C 16, 17, 18, 19	C CER2 SMD 10N K 50V	32535918
C 21, 22	C CER1 RAD 15P J 100V	32180003
TRANSISTORS 		
T 2, 4	BC857B 45V 100mA	36145412
T 3	BC847B 45V 100mA	36145312
DIODES 		
D 1	BAV70 70V 215mA	36561954
D 2	LED LG5460GK GREEN 5mm	36910005
D 3, 4	LED LS5460HL RED 5mm	36910004
COILS 		
L 1, 2	COIL AX 56UH 20% 1.5A	45620009
L 3, 4, 7, 8, 9	COIL RAD 10UH 10% 230mA	45630002
L 5, 6	COIL RAD 2.2UH 10% 520mA	45630003
OTHERS 		
IC 1	IR-RECEIVER SFH506-38	36940001
F 1△	FUSE T3,15A HIGH BREAK	43751652
M 1△	COIL MAINS TJ1853	45390013
F 1	FUSEHOLDER CLIP 5*20mm	41540001
Q 2	WIRE PLUG 2-n 410mm	48899814
Q 4	WIRE BUNDLE 8-n 600mm	48899815
Q 5	WIRE BUNDLE 12-n 500mm	48899807
Q 6	CONN RCA 3 IN ROW	41430747
Q 9	CONN S-VHS	41452244
Q 10	CONN PHONO 3,5mm	41910001
SW 1△	MAINS SWITCH 250V 4/80A	41210005
SW 1, 2, 3, 4	TACTILE SWITCH 4 in row	41150685
	CAM. CONNECTOR COVER	86815350
	MODULE HOLDER	86815351

Item Description Order no.

FO712 Horizontal shift module

RESISTORS

RFO 2	SRES 3R3 0W25 5%	3185 0054
RFO 3	RES 56K 0,1W CHIP	3142 5842
RFO 4	RES 100R 0,1W CHIP	Standard
RFO 5	RES 18R 0W10 SMD	3142 5807
RFO 6	RES 82R 0,1 W CHIP	3142 5882
RFO 7	RES 27K 0,1 W CHIP	3142 5839
RFO 8	R CARF 56K J 0W25 FP	3163 0053
RFO 9	RES 220K 0,1W CHIP	3142 5847
RFO 10, 11	RES 1K 0,1W CHIP	3142 5820
RFO 12	RES 100K 0,1W CHIP	3142 5844

CAPACITORS

CFO 3	MKP 330N J 250V	3345 0034
CFO 4	SCAP 56N 400V	3345 0061
CFO 5	MKT 1U0 10% 63V	3312 4758
CFO 6, 7	ELYT 47U 20% 16V	Standard
CFO 8	CER SMD 100N K 25V	3279 0018

TRANSISTORS

TFO 1	BC337-25	3614 7138
TFO 2	BC327-25	3614 7109
TFO 3, 5, 6	BC857B CHI	3614 5412
TFO 4	BC847B	3614 5312

OTHERS

DFO 1, 2	DIODE 1N4937	3657 5353
LFO 1	COIL 82UH 1400mA	4562 0048
TROF2	TRAFO TM2624 HOR.SHIFT	4535 0002
	CABLE FO/Z 6000	4131 4438
	CABLE FO/O	4131 4439
	FOCUS HOLDER PN720019	8448 8480

HH703/705 CRT-module

RESISTORS

RH 1, 6, 7, 8, 37	RES 2K2 0,1W CHIP	3142 5828
RH 2	RES 750R 0,125W CHIP	3142 5656
RH 3, 12, 16	RES 820R 0,25W 5% FP	3163 0044
RH 4, 13, 17	RES 68K 1W	3144 0008
RH 9, 11, 14	RES 1K5 5% SMD	3142 5826
RH 10	RES 1M 0,1W CHIP	3142 5801
RH 15	RES 470K 0,1W CHIP	3142 5848
RH 18,19,21,22,23,24	0W25 C F RES 470R 5%	3166 0014
RH 26	R CARF 33K 5% 0W25 FP	3163 0036
RH 27	R CARF 4M7 5% 0W25	3166 0029
RH 28, 33	RES 1K5 0,5 W	3159 4639
RH 29	R CARF 18K 5% 0W25	Standard
RH 31	R SMD 22R 5% 0W1	Standard
RH 36	RES 100K 0,1W CHIP	3142 5844
RH 38	RES 470R 0,1W SMD	3142 5817
RH 39	RES 1K 0,1W CHIP	3142 5820
RH 40	RES 100R 0,1W CHIP	Standard

CAPACITORS

CH 1	C ELYT 47U 20% 16V	Standard
CH 2, 3, 7, 8, 12, 13	C CER SMD 22N 10% 50V	3253 5914
CH 4, 9, 14, 19	C MKT 22N 10% 250V	3338 0002
CH 5, 10, 15	C CER SMD 68P 5% 50V	Standard
CH 6, 11, 16	CAP 1NF 50V	3253 6203
CH 17	C ELYT 4U7 250V 11x13 HV	3461 0001
CH 18	C ELYT 10U 20% 250V	3461 0002
CH 20	C CER 68P 5% 50V	Standard
CH 21	C MKT 220N 10% 63V	3312 7108

Item Description Order no.		
CH 22	C MKT 8N2 10% 1K5V	3336 0007
CH 23, 24, 25	CAP 150PF 50V CHIP	3212 5511
CH 27	C ELYT 10U 20% 63V	3454 0025
CH 28	C EL RD 100U M 25V	3454 0020

TRANSISTORS

TH 1	BF422	3612 5217
TH 2	BC857B CHI	3614 5412

DIODES

DH 1, 2	BYV36C 600V 1	3657 5452
DH 3, 4	SMD LS4148 75V 200MA	3649 0002
	BZX83C 15V	3677 0017

COILS

LH 1, 6	COIL 10UH 10% 230MA	4562 0003
LH 2*, 3*, 4*	CHOKE 2,2 UH	4557 1751
LH 2*, 3*, 4*	CONNECTION WIRE 12,5mm	4131 4404

OTHERS

	IC TDA6111 N3 DBS9	3744 0004
	PICTURE TUBE SOCKET28	4155 4034
	WIRE BUNDLE 10-PIN 430	4889 9834
XH 1-1	WIRE BUNDLE 6-PIN 370mm	4889 9812
XH 2-1	WIRE BUNDLE 10-PIN 400mm	4889 9811

SW600 140V Switch module

RESISTORS

RSW 1, 5	R CARF 220K 5% 0W25 FP	3163 0045
RSW 2	SWID 4K7 0,25W	3151 4522
RSW 3	FUSE RES 0R47 0,25W	3151 4520
RSW 4	SRES 1K 0,25WWV	3151 4519
RSW 6	R CARF 2K2 5% 0W25 FP	3163 0050
RSW 7	R CARF 4K7 5% 0W25	Standard

CAPACITORS

CSW 1	C ELYT RD 100U M 25V	3454 0020
CSW 2	C MKT 22N 10% 250V	3338 0002

TRANSISTORS

TSW 1	BUK457 400A	3637 0003
TSW 2	BC557B	3614 6424
TSW 3	BF422	3612 5217

DIODES

DSW 2, 3	1N4937	3657 5353
DZSW 1	BZX83C 12	3677 0012

OTHERS

LSW 1	COIL 280UH	4561 0004
	F-CONNECTOR 7-PIN	4175 0001
	MODULE SUPPORT	8318 6233

TA700 Audio output module

RESISTORS

RTA 1	SWID 2R2 J0W125P SMD	3181 0001
RTA 2, 13, 14, 21, 36	RES 470R 0,1W SMD	3142 5817
RTA 3, 4, 5, 15, 16, 22	RES 33K 0,1W CHIP	3142 5840

Item	Description	Order no.
RTA 17, 18	RES 1M 0,1W CHIP	3142 5801
RTA 19, 20	RES 220K 0,1W CHIP	3142 5847
RTA 23	RES 27K 0,1 W CHIP	3142 5839
RTA 24, 31	RES 100K 0,1W CHIP	3142 5844
RTA 25, 33, 34	RES 10K 0,1W CHIP	3142 5833
RTA 26	R SMD 10K0 1% 0W1	3149 0057
RTA 27	R SMD 12K1 1% 0W1	3149 0051
RTA 28	RES 390R 0,1W CHIP	3142 5816
RTA 29	R SMD 464R 1% 0W1	3149 0044
RTA 30	RES 120 K CHIP	3142 5845
RTA 32	R SMD 680K 5% 0W1	3149 0059

CAPACITORS

CTA 1, 6, 11, 13, 16, 19	C CER SMD 100N K 25V	3279 0018
CTA 2	C ELYT 10U 20% 16V	3454 0032
CTA 3, 4, 15, 17, 18	C ELYT 22U 20% 16V	Standard
CTA 5	C ELYT 47U M 16V 2R	3454 0045
CTA 7, 8	C ELYT 1U0 20% 50V	3454 0030
CTA 9, 10	CAP 10 NF 50V CHIP	3253 6213
CTA 12	C ELYT 100MF 16V	3454 0031
CTA 14	C CER SMD 470P 5% 50V	Standard

TRANSISTORS

TTA 1, 2, 8, 9	N-FET SMD 2N7002 60V 180	3638 0002
TTA 3, 4, 6, 7	BC 847B	3614 5312
TTA 5	BC 857B CHI	3614 5412

DIODES

DTA 1	SMD LS4148 75V 200MA	3649 0002
DTA 2, 3	WID 0 E 0,125W CHIP JUMP	3142 5601

INTEGRATED CIRCUITS

ICTA 1	TL082CD SO SMD	3747 0003
ICTA 2	LM358 SMD SO8	3747 0008

OTHERS

LTA 1, 2, 3, 4	COIL 10UH 10% 230MA	4562 0003
XT 7	CONNECTOR RCA RED	4192 0001
XT 8	CONNECTOR RCA WHITE	4192 0002

TA710/711 Scart 3 module**RESISTORS**

RA 1, 36	R FUS V 2R2 5% 0W25	3186 0003
RA 4,5,6,7,13,24,25,38, 39,40,41,42,43	RES 100K 0,1W CHIP	3142 5844
RA 8,14,15,16,17,31	RES 75R 0,1W CHIP	3142 5861
RA 9	RES 6K8 0,1W CHIP	3142 5831
RA 10, 27, 28, 34	RES 220R 0,1W SMD	3142 5815
RA 11, 12, 44, 45	RES 470R 0,1W SMD	3142 5817
RA 18	RES 18K 0,1W CHIP	3142 5813
RA 19, 26	RES 4K7 0,1W CHIP	3142 5824
RA 20, 21	RES 10K 0,1W CHIP	3142 5833
RA 22, 23, 35, 37	RES 33K 0,1W CHIP	3142 5840
RA 29, 30, 32, 33	RES 220K 0,1W CHIP	3142 5847

CAPACITORS

CA 1, 11, 22	C ELYT 10U 20% 63V	3454 0025
CA 2, 10, 21, 23, 24, 25, 30, 31, 32	CAP 100NF 50V CER	3253 5920
CA 3	C MKT 220N 10% 63V	3312 7108
CA 5	C CER SMD 390P 5% 50V	Standard
CA 6, 7	CAP 330PF 50V	3212 5517
CA 8, 9, 16, 17	CAP 10NF 50V CHIP	3253 5918
CA 12, 13, 14, 15, 18, 19, 34	POLYESTER 330N 63V PAN 2	3312 7113

Item	Description	Order no.
CA 26, 27, 28, 29	CAP 33PF 50V CHIP	Standard
CO 33	POLYESTER 330N 63V PAN 2	3312 7113

INTEGRATED CIRCUITS

ICA 1	MC33078D	3747 0007
ICA 2	TDA8601 SO16 SMD	3744 0045
ICA 3	CD4052	3771 7370

COILS

LA 1	COIL 2.2UH 10% 520MA	4563 0003
LA 2, 3	COIL 10UH 10% 230MA	4563 0002

OTHERS

DA 1, 2	DIODE SMD LS4148 75V 200mA	3649 0002
TA 2, 4	TRANSISTOR BC847B	3614 5312

XA 1	WIRE BUNDLE 12n 200mm	4131 4436
XA 3	WIRE BUNDLE 8N 200MM	4131 4434
XA 3	WIRE BUNDLE 12N 200mm	4131 4436
XA 4	WIRE BUNDLE 6-PIN 200MM	4889 9808
XA 6	SCART CONNECTOR ORANG	4191 0005
XA 7	CONN RCA VERT RE+WH	4191 0015
	FIXING PLATE SCART R1/F3	8448 8340

VD705 Vertical dumping module

PVD 1	CAP 10N 250V	3345 0057
RVD 2, 3, 4	RES 820R 0,25W 5% FP	3163 0044
RVD 5	RES 100RJ 3W0 MET	3144 0043
	SRES 27R 0,25W	3186 0001
	SRES 27R 0,25W	3186 0001

VD710 Vertical dumping module

RVD 2, 3, 4, 5, 6	WID 680R 5% 0,25W	3163 0043
RVD 7	SRES 27R 0,25W	3186 0001
CVD 1	CAP 10N 250V	3345 0057

VM600 SVM-module**RESISTORS**

RVM 1	RES 3K9 0,1W CHIP	Standard
RVM 2, 11, 12	RES 470R 0,1W SMD	3142 5817
RVM 3	RES 10K 0,1W CHIP	Standard
RVM 4, 13	RES 1K 0,1W CHIP	3142 5820
RVM 6, 23, 31	SRES 100R 0,25W	3151 4516
RVM 7	RES 680R 0,1 W CHIP	Standard
RVM 8	RES 100R 0,1W CHIP	Standard
RVM 9, 14	RES 820R 0,1W CHIP	Standard
RVM 16, 17	R SMD 47R 5% 0W1	Standard
RVM 18, 21	RES 6K8 0,1W CHIP	Standard
RVM 19	RES 560R CHIP	3142 5818
RVM 22	S RES 330R 0,25W	3151 4524
RVM 24, 32	RES 3R3 0,25W	3151 4515
RVM 26, 28	S RES 10R 0,25W	3151 4513
RVM 27, 29	RES 5K6 0,1W CHIP	3142 5825
RVM 33	R METF 100R F 0W60	3145 0016

CAPACITORS

CVM 1	CAP 15 PF 50V	Standard
CVM 2	CAP 47PF 50V CHIP	Standard
CVM 3,6,12,13,14,16,17	CAP 100NF 50V CER	Standard
CVM 4	CAP 10NF 50V CHIP	3253 5918
CVM 7, 8	C CER SMD 22N 10% 50V	Standard
CVM 9	C ELYT 10U 20% 63V	3454 0025